

# AMERICAN AUDIO

## UCD-100 MKIII CD/USB MP3 PLAYER

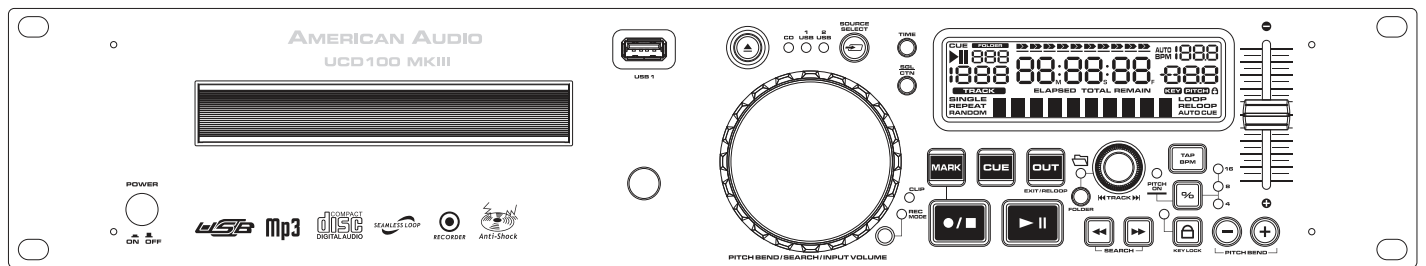

## Operating Instructions



American Audio®  
6122 S. Eastern Ave.  
Los Angeles, CA 90040  
Rev. 2/15

# CONTENTS

|                                       |       |
|---------------------------------------|-------|
| SAFETY PRECAUTIONS.....               | 3     |
| ELECTRICAL SAFETY PRECAUTIONS.....    | 4     |
| PRODUCT INFORMATION.....              | 5     |
| CUSTOMER SUPPORT.....                 | 6     |
| SET-UP.....                           | 7     |
| FUNCTIONS AND CONTROLS.....           | 8     |
| BASIC OPERATION                       |       |
| LOADING/EJECTING DISC/USB DEVICE..... | 14-15 |
| SELECTING TRACKS.....                 | 15    |
| STARTING/STOPPING PLAYBACK.....       | 16    |
| FRAME SEARCH.....                     | 17    |
| CHANGE TIME DISPLAY.....              | 18    |
| PITCH ADJUSTMENT.....                 | 19    |
| CREATING SEAMLESS LOOPS.....          | 21    |
| INTERNAL MENU.....                    | 23    |
| DATABASE BUILDER.....                 | 24    |
| TROUBLESHOOTING.....                  | 27    |
| POWER DOWN PROCEDURES.....            | 28    |
| HANDLING COMPACT DISC.....            | 28    |
| WARRANTY.....                         | 29    |
| SPECIFICATIONS.....                   | 30    |

**CHECK THE AMERICAN AUDIO WEBSITE FOR DOWNLOADABLE USER SOFTWARE UPDATES.**

## FOR BEST CD-R DISC PLAYBACK RESULTS IN THIS CD PLAYER PLEASE FOLLOW THESE GUIDELINES:

- 1. High quality CD-R Audio discs (should conform to the standards of the Orange Book 2).**
- 2. Use a high quality bit rate when recording discs. (At least 160kbps)**
- 3. Record discs in the slowest speed possible. (i.e. 2x or 4x speed)**

## MAIN FEATURES

- 8 times over sampling 1 bit D/A converter
- Auto cue
- Front Loading CD System
- Record to USB (See page 22)
- Pitch Control and Bend (+/-4%, +/-8%, +/-16%)
- Single Rackmount unit
- 1/75th second frame search
- Jog Wheel for frame search in Pause Mode and Pitch Bend in Play Mode
- 8 different speed scan (4 Forward/4 Reverse)
- RCA Output & Balanced XLR Output (Use only one of the outputs at a time. The UCD-100 MKIII is not designed for dual output.)
- RCA Inputs to connect external audio devices
- Seamless Loop
- Pitch Percentage Display
- Instant Start within 10 ms (sound is produced immediately when the PLAY button is pressed)

## SAFETY PRECAUTIONS

NOTE: This CD player uses a semiconductor laser. It is recommended for use in a room at the following temperature: 41°F - 95°F / 5°C - 35°C

### CAUTION:

1. Handle the power supply cord carefully. Do not damage or deform; it may cause electric shock or malfunction when used. Hold plug attachment when removing from wall outlet. Do not pull on the cord.
2. To avoid electric shock, do not open the top cover when the unit is plugged in. If problems occur with the unit, call your local American Audio® dealer.
3. Do not place metal objects or spill liquid inside the CD player. Electric shock or malfunction may occur.

The serial and model number for this unit is located on the rear panel. Please write down the numbers here and retain for future reference.

Model No. \_\_\_\_\_

Serial No. \_\_\_\_\_

NOTE: This product satisfies FCC regulations when shielded cables and connectors are used to connect the unit to other equipment. To prevent electromagnetic interference with electrical appliances such as radios and televisions, use shielded cables and connectors for connections.

### CAUTION:

USE OF CONTROLS OR ADJUSTMENTS OTHER THAN THOSE SPECIFIED HEREIN MAY RESULT IN HAZARDOUS RADIATION EXPOSURE

THE COMPACT DISC PLAYER SHOULD NOT BE ADJUSTED OR REPAIRED BY ANYONE EXCEPT PROPERLY QUALIFIED SERVICE PERSONNEL.

CAUTION: TO PREVENT ELECTRIC SHOCK DO NOT USE THIS (POLARIZED) PLUG WITH AN EXTENSION CORD, RECEPTACLE, OR OTHER OUTLET UNLESS THE BLADES CAN BE CAREFULLY INSERTED TO PREVENT BLADE EXPOSURE

ATTENTION: POUR PREVENIR LES CHOCS ELECTRIQUES NE PAS UTILISER CETTE FICHE POLARISEE AVEC UN PROLONGATEUR, UNE PRISE DE COURANT OU UNE AUTRE SORTIE DE COURANT, SAUF SI LES LAMES PEUVENT ETRE INSEREES A FOND SANS EN LAISSER AUCUNE PARTIE A DECOUVERT.

WARNING: TO PREVENT FIRE OR SHOCK HAZARD, DO NOT EXPOSE THIS UNIT TO WATER OR MOISTURE

This equipment has been tested and found to comply with the limits for a Class B digital device, pursuant to Part 15 of the FCC Rules. These limits are designed to provide reasonable protection against harmful interference in a residential installation. This equipment generates, uses, and can radiate radio frequency energy and, if not installed and used in accordance with the instructions, may cause harmful interference to radio communications. However, there is no guarantee that interference will not occur in a particular installation. If this equipment does cause harmful interference to radio or television reception, which can be determined by turning the equipment off and on, the user is encouraged to try to correct the interference by one or more of the following measures:

- Reorient or relocate the receiving antenna.
- Increase the separation between the equipment and receiver.
- Connect the unit into an electrical outlet on a circuit different from that to which the receiver is connected.
- Consult the dealer or an experienced radio/TV technician for help.

# ELECTRICAL SAFETY PRECAUTIONS

## ELECTRICAL PRECAUTIONS



The lightning flash with arrowhead symbol, within an equilateral triangle, is intended to alert the user to the presence of uninsulated "dangerous voltage" within the product's enclosure that may be of sufficient magnitude to constitute a risk of electric shock to persons.

**CAUTION**  
RISK OF ELECTRIC SHOCK  
DO NOT OPEN

CAUTION: TO REDUCE THE RISK OF ELECTRIC SHOCK, DO NOT REMOVE THE COVER (OR BACK). THERE ARE NO USER SERVICEABLE PARTS INSIDE. REFER SERVICE TO YOUR AUTHORIZED AMERICAN AUDIO® SERVICE TECHNICIAN.



The exclamation point within an equilateral triangle is intended to alert the user to the presence of important operating and maintenance (servicing) instructions in the literature accompanying the appliance.

## IMPORTANT SAFETY INSTRUCTIONS

**READ INSTRUCTIONS** — All the safety and operating instructions should be read before the product is operated.

**RETAIN INSTRUCTIONS** — The safety and operating instructions should be retained for future reference.

**HEED WARNINGS** — All warnings on the product and in the operating instructions should be adhered to.

**FOLLOW INSTRUCTIONS** — All operating and use instructions should be followed.

**CLEANING** — The product should be cleaned only with a polishing cloth or a soft dry cloth. Never clean with furniture wax, benzene, insecticides or other volatile liquids since they may corrode the cabinet.

**ATTACHMENTS** — Do not use attachments not recommended by the product manufacturer as they may cause hazards.

**WATER AND MOISTURE** — Do not use this product near water — for example, near a bathtub, wash bowl, kitchen sink, or laundry tub; in a wet basement; or near a swimming pool; and the like.

**ACCESSORIES** — Do not place this product on an unstable cart, stand, tripod, bracket, or table. The product may fall, causing serious injury to a child or adult, and serious damage to the product. Use only with a cart, stand, tripod, bracket, or table recommended by the manufacturer, or sold with the product. Any mounting of the product should follow the manufacturer's instructions, and should use a mounting accessory recommended by the manufacturer.

**CART** — A product and cart combination should be moved with care. Quick stops, excessive force, and uneven surfaces may cause the product and cart combination to overturn.



**VENTILATION** — Slots and openings in the cabinet are provided for ventilation and to ensure reliable operation of the product and to protect it from overheating, and these openings must not be blocked or covered. The openings should never be blocked by placing the product on a bed, sofa, rug, or other similar surface. This product should not be placed in a built-in installation such as a bookcase or rack unless proper ventilation is provided or the manufacturer's instructions have been adhered to.

**POWER SOURCES** — This product should be operated only from the type of power source indicated on the marking label. If you are not sure of the type of power supply to your home, consult your product dealer or local power company.

**LOCATION** — The appliance should be installed in a stable location.

**NONUSE PERIODS** — The power cord of the appliance should be unplugged from the outlet when left unused for a long period of time.

### GROUNDING OR POLARIZATION

- If this product is equipped with a polarized alternating current line plug (a plug having one blade wider than the other), it will fit into the outlet only one way. This is a safety feature. If you are unable to insert the plug fully into the outlet, try reversing the plug. If the plug should still fail to fit, contact your electrician to replace your obsolete outlet. Do not defeat the safety purpose of the polarized plug.

- If this product is equipped with a three-wire grounding type plug, a plug having a third (grounding) pin, it will only fit into a grounding type power outlet. This is a safety feature. If you are unable to insert the plug into the outlet, contact your electrician to replace your obsolete outlet. Do not defeat the safety purpose of the grounding type plug.

**POWER-CORD PROTECTION** - Power-supply cords should be routed so that they are not likely to be walked on or pinched by items placed upon or against them, paying particular attention to cords at plugs, convenience receptacles, and the point where they exit from the product.

**OUTDOOR ANTENNA GROUNDING** — If an outside antenna or cable system is connected to the product, be sure the antenna or cable system is grounded so as to provide some protection against voltage surges and built-up static charges. Article 810 of the National Electrical Code, ANSI/NFPA 70, provides information with regard to proper grounding of the mast and supporting structure, grounding of the lead-in wire to an antenna discharge unit, size of grounding conductors, location of antenna-discharge unit, connection to grounding electrodes, and requirements for the grounding electrode. See Figure A.

**LIGHTNING** — For added protection for this product during a lightning storm, or when it is left unattended and unused for long periods of time, unplug it from the wall outlet and disconnect the antenna or cable system. This will prevent damage to the product due to lightning and power-line surges.

**POWER LINES** — An outside antenna system should not be located in the vicinity of overhead power lines or other electric light or power circuits, or where it can fall into such power lines or circuits. When installing an outside antenna system, extreme care should be taken to keep from touching such power lines or circuits as contact with them might be fatal.

**OVERLOADING** — Do not overload wall outlets, extension cords, or integral convenience receptacles as this can result in a risk of fire or electric shock.

**OBJECT AND LIQUID ENTRY** - Never push objects of any kind into this product through openings as they may touch dangerous voltage points or short-out parts that could result in a fire or electric shock. Never spill liquid of any kind on the product.

**SERVICING** — Do not attempt to service this product yourself as opening or removing covers may expose you to dangerous voltage or other hazards. Refer all servicing to qualified service personnel.

**DAMAGE REQUIRING SERVICE** - Unplug this product from the wall outlet and refer servicing to qualified service personnel under the following conditions:

- When the power-supply cord or plug is damaged.
- If liquid has been spilled, or objects have fallen into the product.
- If the product has been exposed to rain or water.
- If the product does not operate normally by following the operating instructions. Adjust only those controls that are covered by the operating instructions as an improper adjustment of other controls may result in damage and will often require extensive work by a qualified technician to restore the product to its normal operation.
- If the product has been dropped or damaged in any way.
- When the product exhibits a distinct change in performance — this indicates a need for service.

**REPLACEMENT PARTS** — When replacement parts are required, be sure the service technician has used replacement parts specified by the manufacturer or have the same characteristics as the original part. Unauthorized substitutions may result in fire, electric shock, or other hazards.

**SAFETY CHECK** - Upon completion of any service or repairs to this product, ask the service technician to perform safety checks to determine that the product is in proper operating condition.

**WALL OR CEILING MOUNTING** — The product should not be mounted to a wall or ceiling.

**HEAT** — The product should be situated away from heat sources such as radiators, heat registers, stoves, or other products (including amplifiers) that produce heat.

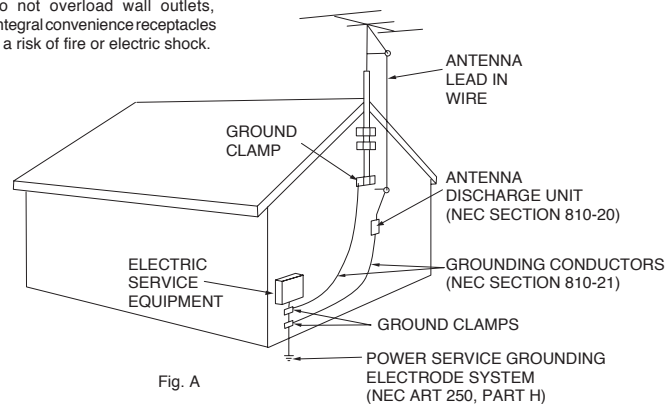

Fig. A

NEC — NATIONAL ELECTRICAL CODE

## **PRODUCT INFORMATION**

1. Read Instructions - All the safety and operating instructions should be read before the CD Player is operated. The safety and operating instructions should be saved for future reference.
2. Heed Warnings - All warnings on the Player and in the operating instructions should be adhered to.
3. Water and Moisture - The player should not be used near water - for example, near a bath tub, kitchen sink, laundry tub, in a wet basement or near a swimming pool, etc.
4. Ventilation - The Player should be situated so that its location or position does not interfere with its proper ventilation. For example, the player should not be situated on a bed, sofa, rug, or similar surface that may block the ventilation openings; or, placed in a built-in installation, such as a bookcase or cabinet that may impede the flow of air through the ventilation openings.
5. Heat - The player should be situated away from heat sources such as radiators, heat registers, stoves, or other appliances (including amplifiers) that produce heat.
6. Power Sources - The player should be connected to a power supply only of the type described in the operating instructions or as marked on the Player.
7. Servicing - The user should not attempt to service the Player beyond that described in the operating instructions. All other servicing should be referred to qualified service personnel. The Player should be serviced by qualified service personnel when:
  - A. The power-supply cord or the plug has been damaged.
  - B. Objects have fallen, or liquid has been spilled into the Player.
  - C. The Player has been exposed to rain or water.
  - D. The Player does not appear to operate normally or exhibits a marked change in performance.

---

## **WARRANTY INFORMATION**

The UCD-100 MKIII carries a ONE year (365 days) limited warranty. This warranty covers parts and labor. Please fill out the enclosed warranty card to validate your purchase. All returned service items whether under warranty or not, must be freight pre-paid and accompany a return authorization (R.A.) number. The R.A. number must be clearly written on the outside of the return package. A brief description of the problem as well as the R.A. number must also be written down on a piece of paper and included in the shipping container. If the unit is under warranty, you must provide a copy of your proof of purchase invoice. You may obtain a R.A. number by contacting customer support at (800) 322-6337.

---

## UNPACKING

Every UCD-100 MKIII has been thoroughly tested and has been shipped in perfect operating condition. Carefully check the shipping carton for damage that may have occurred during shipping. If the carton appears to be damaged, carefully inspect your player for any damage and be sure all equipment necessary to operate the player has arrived intact. In the event damage has been found or parts are missing, please contact our toll free customer support number for further instructions. Please do not return the player to your dealer without first contacting customer support.

## INTRODUCTION

### **Introduction:**

Congratulations and thank you for purchasing the American Audio® UCD-100 MKIII. This player is a representation of American Audio's continuing commitment to produce the best and highest quality audio products possible at an affordable price. Please read and understand this manual completely before attempting to operate your new player. This booklet contains important information concerning the proper and safe operation of your new player.

### **Customer Support:**

American Audio® provides a toll free customer support line, to provide set up help and answer any question should you encounter problems during your initial set up or operation. You may also visit us on the web at [www.americanaudio.com](http://www.americanaudio.com) for any comments or suggestions. Service Hours are Monday through Friday 9:00 a.m. to 5:30 p.m. Pacific Standard Time.

Voice: (800) 322-6337  
Fax: (323) 582-2610  
E-mail: [support@americandj.com](mailto:support@americandj.com)

To purchase parts online visit <http://parts.americandj.com>

**Caution!** There are no user serviceable parts inside this player. Do not attempt any repairs yourself, without being instructed to do so by an authorized American Audio service technician. Doing so will void your manufactures warranty. In the unlikely event your player may require service, please contact American Audio® customer support.

Do not discard the packing carton in the trash. Please recycle when ever possible.

## SET-UP PRECAUTIONS

Please be sure to make any connections before plugging the player into an electrical outlet. All fader and volume controls should be set to zero or minimum position, before the player is switched on. If the player has been exposed to drastic temperature fluctuation (e.g. after transportation), do not switch on the player immediately. The arising condensation of water might damage your device. Leave the device switched off until it has reached room temperature.

### Operating Determinations:

- When installing this player, please make sure that the device is not exposed or will not be exposed to extreme heat, moisture or dust!
- Do not operate the player in extremely hot (more than 30°/100°F) or extremely cold (less than 5°C/40°F) surroundings.
- Keep the unit out of direct sunlight and away from heaters.
- Operate the player only after becoming familiar with its' functions. Do not permit operation by persons not qualified for operating the unit. Most damages are the result of unprofessional operation.

## SET-UP

### USB INFORMATION:

- Make sure your USB device has only MP3 files on it. There cannot be any other type of files on your USB device, NO photo files, etc...
- If you are using a SD Card via USB SD Card reader, you must remove the USB SD Card reader first to change SD Card's. Please do not remove the SD Card from the USB SD Card reader while the USB card reader is still connected to the unit.
- Only supports FAT/FAT32 formatted devices.

### SD CARD INFORMATION:

- Make sure your SD Card only has MP3 files on it
- Do Not have any other file type on your SD Card; no photo files, etc...
- American Audio SD Players can read SD HC (High Capacity) Cards up to 32GB

### PLEASE NOTE:

For higher quality MP3 files (more than 128 kbps) American Audio recommends "High Speed" SD Cards. Using high speed cards will ensure the best performance with your American Audio SD Player.

#### 1. Checking the Contents

Be sure your UCD-100 MKIII package was shipped with the following:

- 1) UCD-100 MKIII Professional Rackmount Single CD/USB Player
- 2) User Manual (this booklet)
- 3) RCA Cables Stereo Cables
- 4) Warranty Card

#### 2. Installing the Units

- 1) The UCD-100 MKIII is designed to be placed on a flat level surface or installed into a standard 19" rack mount case or enclosure. When mounting the UCD-100 MKIII in a 19" rack be sure to support the unit by all four screw slots on the face of the unit.
- 2) Be sure the player is mounted in a well ventilated area where it will not be exposed to direct sunlight, high temperatures, or high humidity.
- 3) Try to place the unit as far as possible from TV's and tuners, as the unit may cause undesirable interference with such devices.

#### 3. Connections

- 1) Be sure the power is disconnected.
- 2) Connect the included RCA cable from your UCD-100 MKIII outputs to the inputs on your mixer.
- 3) Use the Digital Output to connect to MiniDisc, DAT machines, or other device that accepts digital inputs.

### CAUTION:

To avoid severe damage to the unit, be sure the power is off when making connections to the unit.

### CAUTION:

- The player will work normally when the main unit is mounted with the front panel within 15 degrees of the vertical plane. If the unit is tilted excessively, disks may not be loaded or unloaded properly.

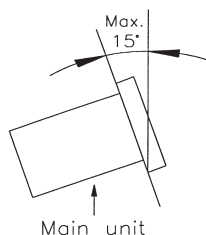

# FUNCTIONS AND CONTROLS

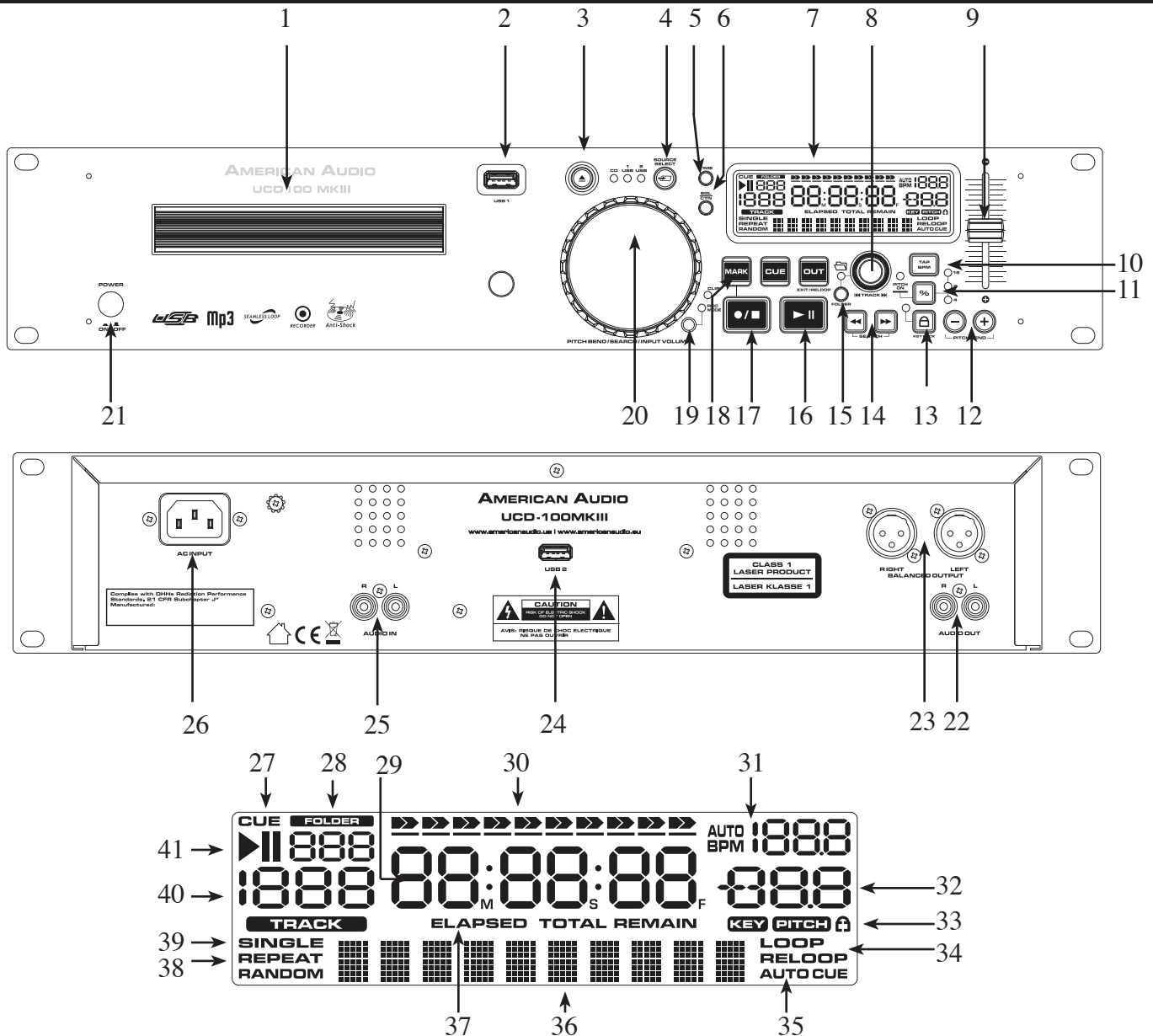

## A. FRONT PANEL CONTROLS

**1. DISC TRAY** - This tray is used to load and unload a compact disc into the drive mechanism. The tray is opened and closed by pressing the *OPEN/CLOSE BUTTON* (3). Never attempt to force the transport tray open or closed when the power is turned off.

**2. USB PORT 1** - This is USB port 1 is where you can insert a USB stick, USB, memory Card reader, or compatible external hard drive for playback or record. See page 22 for recording instructions. **VERY IMPORTANT: PLEASE SEE PAGE 7 FOR DETAILS REGARDING/USING USB DEVICES.**

**3. OPEN/CLOSE (Disc Tray Open/Close)** - This button is used to open and close the disc tray. NOTE: When a disc is already loaded in the disc tray. The tray will not open unless the unit is in pause or cue mode.

**4. SOURCE SELECTOR** - Press this button to select your desired playback source. Select either CD Player, USB 1, or USB 2. The source indicator LED will light when the selected source is activate.

**5. TIME** - The TIME button is used to changed the displayed time values and enter the internal menu. Time can be displayed as elapsed track time, remaining track time, and total disc remaining time. Press this button for at least 2 seconds to enter the internal menu. Use the FOLDER/TRACK KNOB (8) to scroll through the internal menu.



## FUNCTIONS AND CONTROLS

**6. SGL/CTN** - This button has two functions; it allows the unit's play mode to change between Single and Continuous and it activates Auto Cue. In single mode the unit will play a single track and return to cue mode. In continuous mode the unit continues to play track by track. Press and hold this button for at least 1 second to activate or deactivate AUTO CUE.

**7. LIQUID CRYSTAL DISPLAY (LCD)** - This high quality LCD Indicates all the unit functions (play, pause, cue, etc...), as they occur as well as displaying the time and track values.

**8. FOLDER/TRACK KNOB** - This knob is used to search either for folders or tracks. When the LED of the *FOLDER BUTTON (15)* is lit, the player is in FOLDER search mode. When the unit is in track search mode, turn the knob clockwise to search forward, and counter-clockwise to search backwards. Press the knob to cycle to show either song title, album title, genre, or artist. If you press the knob in and turn it while in track mode, you can skip ahead 10 tracks. *Example: if you are at Track #1, pressing the knob and turning it clockwise will skip you to Track #11. If you press the knob and turn it clockwise again, it will skip to Track #21. If there are not that many tracks, it will go back to Track #1.*

**9. PITCH SLIDER** - This slider is used to adjust the playback pitch percentage when the *PITCH (11)* function is activated. The slider is a set adjustment and will remain set until the pitch slider is moved or the *PITCH (11)* function has been turned off. This adjustment can be made with or without a CD in the drive. The pitch adjustment will remain even if a disc has been remove, and will reflect on any other disc loaded into the unit. That is to say, if you set a +2% pitch on one disc, remove that disc and insert another, that disc too will have a +2% pitch. The amount of pitch being applied will be displayed in the *LCD (7)*. Use this slider to match the BPM's of this unit to that of another music source. By changing the pitch of one disc with respect to the other in this way, the beats can be matched.

**10. TAP/BPM BUTTON** - Press this button to switch between manual BPM and Auto BPM. When in manual BPM mode, tap this button to the beat of the current track.

**11. PITCH BUTTON/ PITCH PERCENTAGE SELECTOR** - This button is used to turn the pitch function on and off and choose the pitch percentage. The pitch percentages to choose from are 4%, 8%, 16%, and 100%. When all 3 pitch percentage LEDs are lit, 100% pitch bend is active. To activate the pitch slider press the button for at least 3 seconds. The pitch functions of the *PITCH SLIDER (9)*, *PITCH BEND BUTTONS (12)*, and *JOG WHEEL (20)* will not function without this function being activated. See page 19 for more details. **The pitch slider and “+” and “-” pitch bend buttons have a maximum range of +/-100% for CD's only. Memory sticks have a maximum range of +/-16%.**

### **12. PITCH BEND BUTTONS -**

**(-) PITCH BEND/VOLUME CONTROL** - The (-) pitch bend function creates a momentary “Slow Down” in the CD's pitch speed (Beats per minute - BPM) when the *PITCH (11)* function is activated. This function allows the beats between two CD's or any other music source to match. This is a momentary function. When the button is depressed the pitch speed will automatically return to *PITCH SLIDER'S (9)* selected pitch. Holding down this button will give a maximum of -16% pitch. Be sure to remember that this function is a momentary pitch adjustment, for a more precise adjustment use the *PITCH SLIDER'S (9)* to match the BPM's with another playing music source. This button can also lower the output volume level, please see page 18.

**(+) PITCH BEND/VOLUME CONTROL** - The (+) pitch bend function creates a momentary “BUMP” in the CD's pitch speed (Beats per minute - BPM) when the *PITCH (11)* function is activated. This function allows the beats between two CD's or any other music source to match. This is a momentary function. When the button is depressed the pitch speed will automatically return to *PITCH SLIDER'S (9)* selected pitch. Holding down this button will give a maximum of +16% pitch. Be sure to remember that this function is a momentary pitch adjustment, for a more precise adjustment use the *PITCH SLIDER'S (9)* to match the BPM's with another playing music source. This button can also raise the output volume level, please see page 18.

**13. TEMPO LOCK FUNCTION** - This button activates the TEMPO LOCK function. This function allows you to use the *PITCH SLIDER (9)* to speed up or slow down playback speed without altering the tonal pitch of the track. When this function is not engaged the original tonal pitch of the track will be altered giving you the

## FUNCTIONS AND CONTROLS

“chipmunk” effect when a track is played at a high rate of speed, or the “James Earl Jones” effect when a track is slowed to much.

### 14. SEARCH BUTTONS -

◀◀ This search button allows you to quickly scan backwards through a track.

▶▶ This search button allows you to quickly scan forwards through a track.

**15. FOLDER BUTTON** - Press this button to activate Folder search mode. When active you can use the *FOLDER/TRACK KNOB* (8) to search for your desired folder. Press this button for at least 2 seconds to activate repeat mode.

**16. PLAY/PAUSE BUTTON** - Each press of the PLAY/PAUSE Button causes the operation to change from play to pause or from pause to play. While in play mode the green play button LED will glow, and while in pause mode the green play LED will flash.

**17. STOP/RECORD BUTTON** - Press this button to start or stop the RECORD function. When recording, the button LED will flash. The recorded files will be saved as REC xxxxx.mp3 in the USB driver REC. directory.

### 18. MARK, CUE, & OUT -

**MARK BUTTON** - A recording will be saved in a file when the MARK BUTTON is pressed during recording.

**CUE** - Pressing the CUE button during playback immediately pauses playback and returns the track to the last set cue point. The red CUE BUTTON LED will glow when the unit is in cue mode The LED will also flash every time a new CUE POINT is set. The CUE button can also be held down to momentarily play music. When you release the CUE button it instantly returns to the last set CUE POINT.

**OUT BUTTON/EXIT/RELOOP** - This button is used to set the ending point of a loop. A loop is started by pressing the IN BUTTON, pressing the OUT BUTTON set the loop ending point. The loop will continue to play until the OUT BUTTON is pressed once again.

If a LOOP has been made (see setting a LOOP on page 21), but the CD Player is not actively in LOOP mode (a loop is not playing), pressing the RELOOP BUTTON will instantly reactivate the LOOP mode. To exit the loop, press the LOOP OUT BUTTON.

**19. RECORD MODE BUTTON** - This button is used to switch RECORD / NORMAL mode. When REC MODE LED is on, the recording information will illustrate in the display as below.

ELAPSED TIME: Indicates the elapsed time of a recorded file.

REMAIN TIME: Indicates the remaining time of a recorded file.

TOTAL REMAIL: Indicates the remaining time of the whole USB device.

When CLIP LED is lit, the REC. input level is over the safety ranger.

**20. JOG WHEEL** - The jog wheel serves two functions depending on the current operating mode:

- A. The jog wheel will act as a slow frame search control when the unit is in pause or cue mode allowing you to set a specific cue point or find a particular starting point.
- B. The wheel also works as a momentary pitch bend during playback. Turning the wheel clockwise will increase the pitch percentage up to 16%, and turning the wheel in the counter-clockwise direction will decrease the pitch percentage up to -16%. The pitch bend will be determined on how fast you turn the wheel.

**21. POWER SWITCH** - This switch is used to turn ON/OFF the unit's main power.

### B. REAR PANEL -

**22. AUDIO OUT R & L** - These jacks are used to send a left and right output signal. Use these jacks to send an audio signal to a mixer or receiver. The red colored jack represents the right channel output and white jack represents the left channels output.

**23. BALANCED XLR MASTER OUTPUT JACKS** - The Master Output includes a pair of XLR Balanced

## FUNCTIONS AND CONTROLS

jacks as well as a pair of *AUDIO OUT RCA JACKS (22)*. The 3-pin XLR jacks send a high current balanced output signal. These jacks should be used when you will be driving an amp or other audio equipment with a balanced input, or whenever you will be running a signal line greater than 15 feet. Always, use these jacks whenever possible.

**24. USB PORT 2** - This is USB port 2 where you can insert your USB device to play Mp3 files.

**25. AUDIO IN R & L** - These jacks are used to send a left and right analog mono input signal. Use these jacks to send an audio signal to a mixer or receiver. The red colored jack represents the right channel output and white jack represents the left channels output. Use these jacks to send audio to this device for recording.

**26. POWER CONNECTION** - This is the main power connection. Only use the supplied polarized power cord. Use of any power cord may result in severe damage to the unit. Be sure the local power source matches the units' required power.

### C. LCD DISPLAY -

**27. CUE INDICATOR** - This indicator will glow when the unit is in CUE mode and will flash every time a new CUE POINT is set.

**28. FOLDER DISPLAY** - This indicates which folder you are in.

**29. TIME METER** - These indicators will detail the current Minutes, Seconds, and Frames. The meter will display either the elapse, total, or remaining time of a track or the entire disc. The display time will depend on the selected time function. The selected time function will be displayed above the TIME METER as either *TOTAL REMAINING, REMAINING TRACK TIME, OR ELAPSED TRACK NAME*.

**30. TIME BAR INDICATOR** - This bar visually details the time defined in the *TIME METER (29)*. As with the *TIME METER (26)*, this bar is also dependent on the selected time function REMAIN, ELAPSED, OR TOTAL REMAIN. This bar will begin to flash when 15 seconds of a track remain and will begin to rapidly flash when three seconds of a track remain. The flashing bar is a great visual reminder a track is about to end. The flashing bar will function regardless of which time mode the unit is in.

**31. BPM METER** - This meter will display the BPM's of the current track.

**32. PITCH METER** - This meter displays the pitch percentage being applied to playback by the *PITCH SLIDER (9)*. If the meter read zero regardless of the *PITCH SLIDER'S (9)* position, the *PITCH (11)* function is not activated.

**33.  TEMPO LOCK** - This will indicate the Tempo Lock function is active.

**34. LOOP/RELOOP INDICATOR** - The LOOP indicator will appear when a loop is ready to be engaged. The RELOOP indicator will flash when a loop is engaged.

**35. AUTO CUE** - This will indicate if the Auto Cue is on or off. Press and hold the *SGL/CTN (6)* for 1 sec. to turn the Auto Cue function on and off. The unit's Auto Cue function will automatically set the cue point at the beginning of each track.

**36. CHARACTER DISPLAY** - This will display the name of the track and/or folder when an Mp3 disc with compatible ID3 tags is loaded into the unit.

**37. TOTAL/REMAIN/ELAPSED INDICATOR** - When TOTAL REMAIN is indicated in the *LCD DISPLAY (7)* the time meter will show the total disc remaining time. When REMAIN is indicated the time meter will show the current track's remaining time. When ELAPSED is indicated the time meter will show the current track's elapsed time.

**38. REPEAT INDICATOR** - This indicates the unit is in repeat play mode, the unit will *CONTINUE* to play all tracks in a selected folder until the mode is deactivated. To activate REPEAT mode, press the *FOLDER BUTTON (15)* for at least 2 seconds to activate and deactivate.

## FUNCTIONS AND CONTROLS

**39. SINGLE INDICATOR** - This indicates the unit is in single play mode, the unit will play a single track and return to CUE mode. If the *SINGLE* indicator is not displayed the unit is in continuous mode.

**40. TRACK INDICATOR** - This double digit indicator details a current track. The number displayed in the track indicator is a direct reference to a track being selected for programming or a track in play, pause, or cue mode.

**41. PLAY INDICATOR** - The “PLAY” indicator will glow when the unit is in play mode.

## FUNCTIONS AND CONTROLS - REMOTE

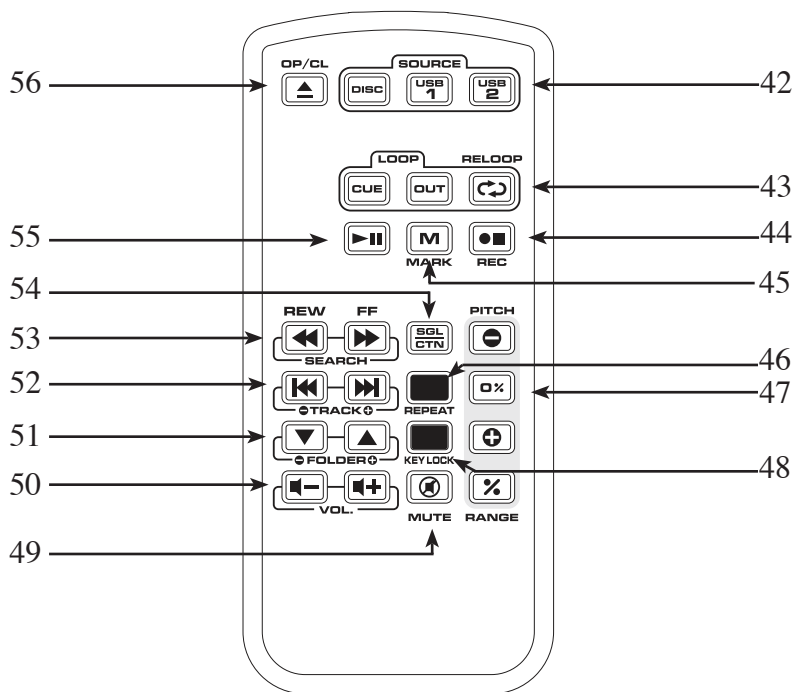

The Max. Range of the remote is 20ft. The beam can be affected by the angle, always aim the remote directly to the IR receiver.

**42. SOURCE SELECTOR** - Press this button to select your desired playback source. Select either CD Player, USB 1, or USB 2. The source indicator LED will light when the selected source is activate. You can also use this button to record a demo from the current playing track.

### 43. CUE, OUT, & RELOOP -

**CUE BUTTON** - “CUE ON THE FLY” - This function allows you to set a CUE POINT (see CUE POINT page 17) without music interruption (“on the fly”). This button also sets the starting point of a loop (see LOOP).

**OUT BUTTON** - This button is used to set the ending point of a loop. A loop is started by pressing the IN BUTTON, pressing the OUT BUTTON set the loop ending point. The loop will continue to play until the OUT BUTTON is pressed once again.

**RELOOP BUTTON** - If a LOOP has been made (see setting a LOOP on page 21), but the CD Player

## FUNCTIONS AND CONTROLS - REMOTE

is not actively in LOOP mode (a loop is not playing), pressing the RELOOP BUTTON will instantly reactivate the LOOP mode. To exit the loop, press the LOOP OUT BUTTON.

**44. RECORD BUTTON** - Use this button activate or deactivate Record mode.

**45. MARK BUTTON** - Used to separate the recording data into several files by each pressing of the MARK button during recording.

**46. REPEAT BUTTON** - This button is used to activate and deactivate the repeat.

**47. PITCH PERCENTAGE & PITCH BEND BUTTONS** -

**(-) PITCH BEND** - The (-) pitch bend function creates a momentary “Slow Down” in the pitch speed (Beats per minute - BPM) when the *PITCH (11)* function is activated.

**0% BUTTON** - This button is used to change the pitch percentage to 0%.

**(+) PITCH BEND** - The (+) pitch bend function creates a momentary “BUMP” in the pitch speed (Beats per minute - BPM) when the *PITCH (11)* function is activated.

**(%) BUTTON** - Press this button for at least 2 seconds to activate PITCH. Press this button to change the pitch percentage.

**48. KEY LOCK** - This button is used to toggle the Master Tempo function on and off.

**49. MUTE BUTTON** - This button is used to mute playback.

**50. VOLUME CONTROL BUTTONS** - These buttons are used to adjust the volume of internal attenuator.

**51. FOLDER SEARCH BUTTONS** - These buttons are used to scroll through the different folders on your MP3 disc or USB device.

**52. TRACK SEARCH BUTTONS** - These buttons are used to scroll either forwards or backwards through a track.

**53. SEARCH BUTTONS** - These buttons are used to scroll through the different tracks.

**54. SGL/CTN** - This button allows the unit's play mode to change between Single and Continuous. In single mode the unit will play a single track and return to cue mode. In continuous mode the unit continues to play track by track.

**55. PLAY/PAUSE BUTTON** - Each press of the PLAY/PAUSE Button causes the operation to change from play to pause or from pause to play. While in play mode the green play button LED will glow, and while in pause mode the green play LED will flash.

**56. OPEN/CLOSE (Transport Tray Open/Close)** - This button is used to open and close the transport tray. NOTE: When a disc is already loaded in the transport tray, the tray will not open unless the unit is in pause or cue mode.

# BASIC OPERATION

## 1. OPENING AND CLOSING THE DISC TRAY

This is an electronic operation and can only work when the power is on. Press the *OPEN/CLOSE BUTTON (3)* to open or close the disc tray. Pressing the *PLAY/PAUSE BUTTON (16)*, will also automatically close the tray if it is open and immediately cue any CD that is in it. If the transport tray is left open for more than 60 seconds it will close automatically to prevent accidental damage to the transport. Again if a CD is left in the transport tray it will immediately cue to the first song. The disc tray cannot be opened during playback to prevent playback from being interrupted if the *OPEN/CLOSE BUTTON (3)* is pressed accidentally. Stop playback, then press the *OPEN/CLOSE BUTTON (3)*.

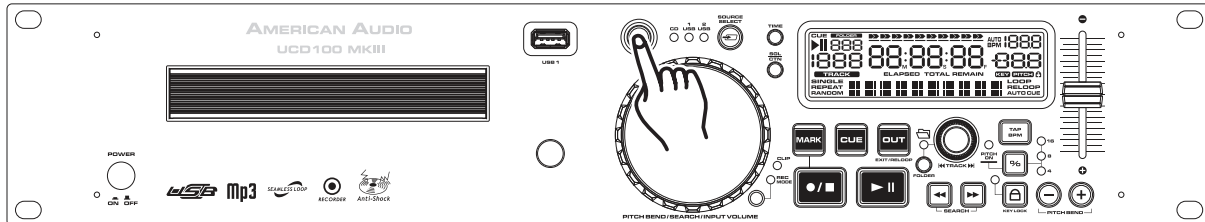

Figure 1

## 2. LOADING DISCS

The UCD-100 MKIII can play both 3 inch (8 cm) and 5 inch (12 cm) compact discs (CD's). Odd shaped and oval CD's are not compatible. When loading a CD into the unit always hold the disc by its' edges and place it in the disc tray. Never touch the signal surface (the glossy side). When using 5 inch/12 cm discs, place the disc in the outer tray guides (figure 2), and when using 3 inch/8 cm discs, place them securely in the inner guides (figure 3).

### CAUTION:

- NEVER insert any foreign objects in the disc tray.
- NEVER attempt to insert more than one disc in the disc tray at a time. Doing so may result in severe damage to the unit.
- NEVER force the transport tray open or closed when the power is off, as this may result in malfunction and damage the transport system.

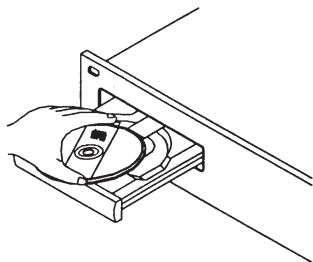

Figure 2 - 5 in. / 12cm disc

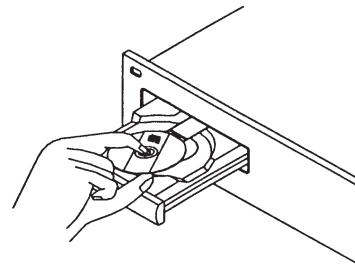

Figure 3 - 3 in. / 8cm disc

## BASIC OPERATION

### 3. LOADING USB DEVICE

The UCD-100 MKIII can only read High Capacity Memory Cards up to 32GB. **The file format is Mp3 only.** When connecting a USB stick, USB card reader, or external hard drive make sure you are correctly lined up with the USB port and gently insert the USB connection. To disconnect a USB drive, stop playback and “pull out” the USB connection. **Please see page 7 for USB information.**

#### CAUTION:

- **NEVER** remove a USB device while in PLAY mode.

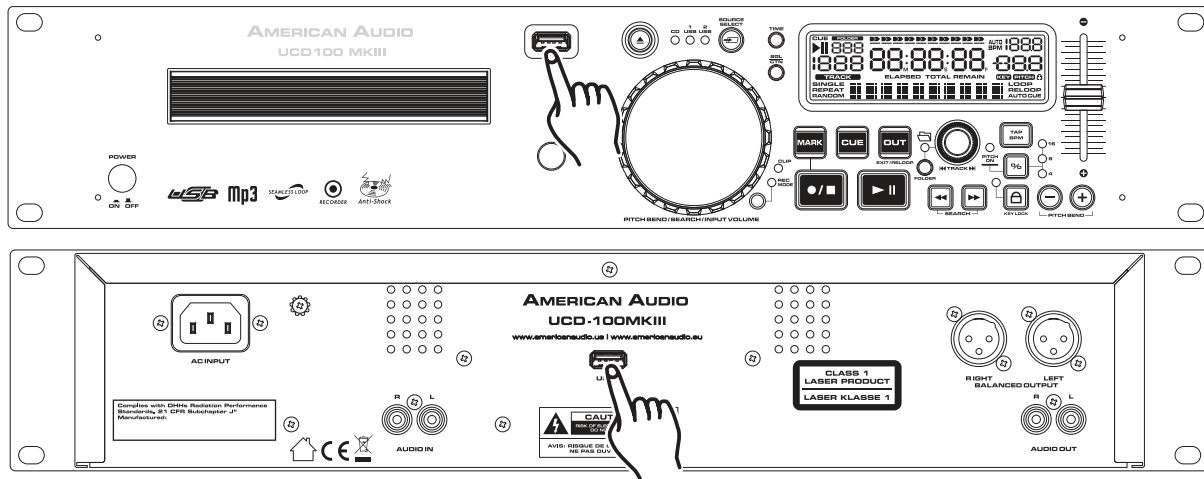

Figure 4

### 4. SELECTING YOUR AUDIO SOURCE

Select your desired audio source using the **SOURCE SELECTOR BUTTON (2)**. This button lets you toggle between either the CD player, USB port 1 and USB port 2. The LED's will verify which source is active. The different sources can only be selected while in PAUSE mode.

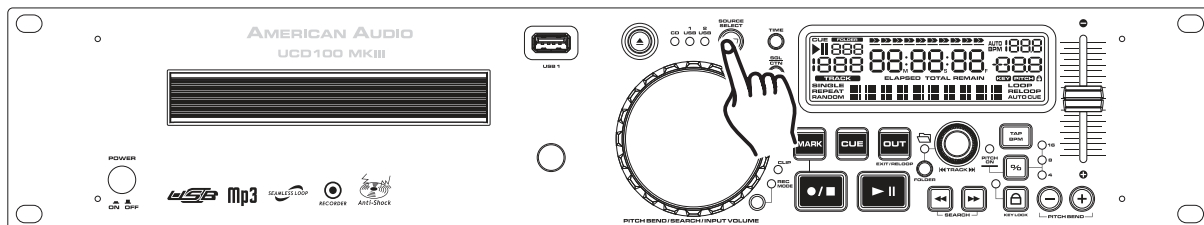

Figure 5

### 5. SELECTING TRACKS

Select a desired track by using the **FOLDER/TRACK KNOB (8)**. Press the **FOLDER/TRACK BUTTON (15)** so that the FOLDER LED is **NOT** lit. Rotate the **FOLDER/TRACK KNOB (8)** clockwise to select the next track, or rotate the knob counter-clockwise to select the previous track. When you are using the knob to select a new track during playback (a track already playing) the new track you selected will immediately begin playback as soon as the search operation is completed.

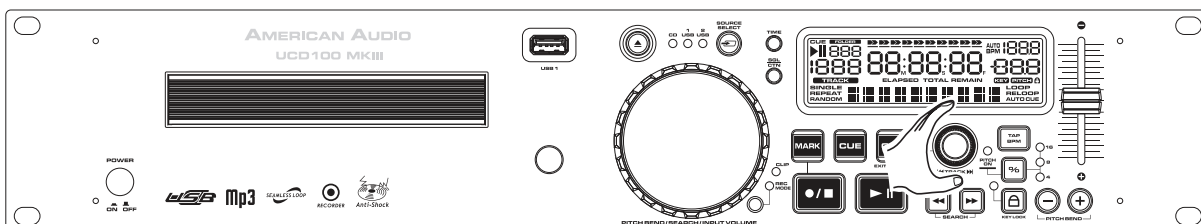

Figure 6

# BASIC OPERATION

## 6. STARTING PLAYBACK

Insert an audio CD as describe on the previous page (*LOADING DISCS*). Pressing the *PLAY/PAUSE BUTTON* (16) with an audio CD inserted will immediately start playback. The point at which playback starts (cue point) will automatically be stored in the memory as the cue point. The unit will return to this cue point (the point at which playback started) when the *CUE BUTTON* (18) is pressed.

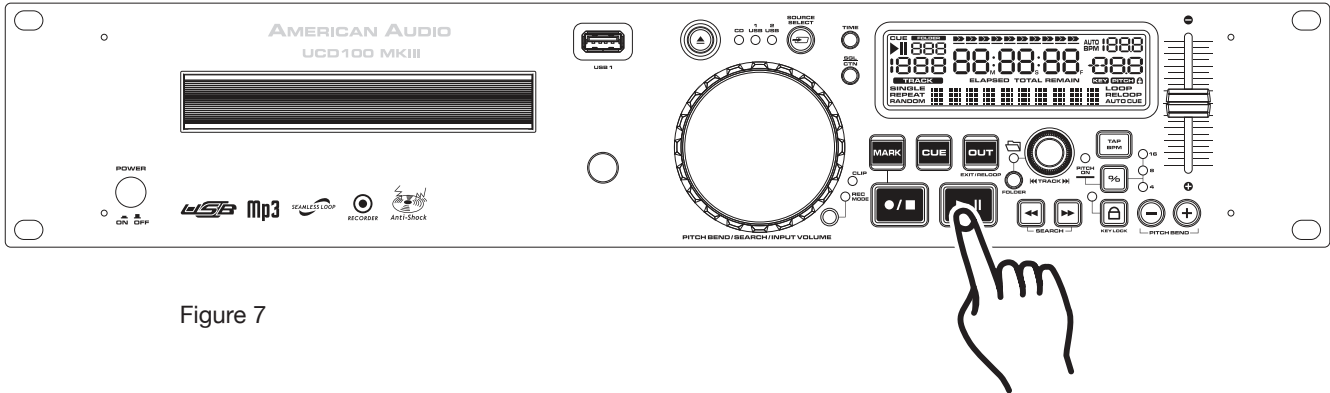

Figure 7

## 7. STOPPING PLAYBACK

Stopping playback will not stop the drive mechanism, but merely pause or cue the track. There are two ways to stop playback:

## 8. PAUSING

Pausing temporarily stops playback. Pressing the *PLAY/PAUSE BUTTON* (16) changes the operating mode between play and pause. The *PLAY/PAUSE BUTTON LED* will flash repeatedly when pause mode is activated or when a track is in cue mode.

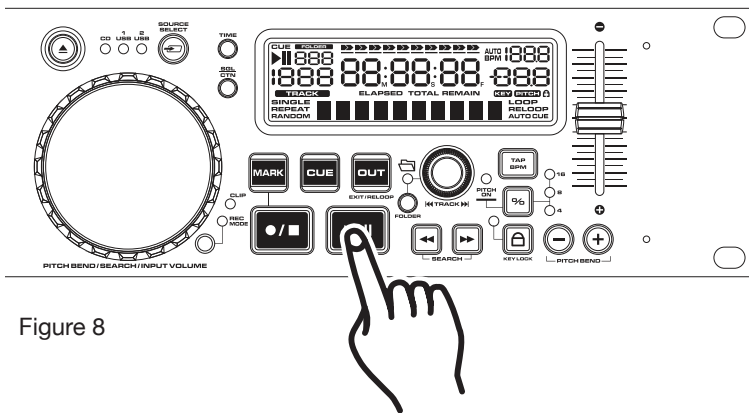

Figure 8

1) Press the *PLAY/PAUSE BUTTON* (16) during playback to pause at that point.

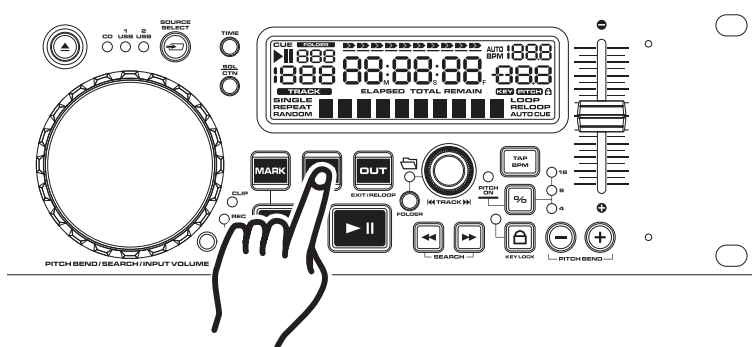

Figure 9

2) Press the *CUE BUTTON* (18) during playback to return the track to it's last cue point.



# BASIC OPERATION

## 9. AUTO CUE

"Cueing" is the action of preparing for playback. The unit is designed to automatically cue at the first audible signal on the first of a disc when a disc is inserted. If a track is selected before a disc is inserted, the unit will automatically cue to the first audible signal for the selected track.

## 10. SETTING CUE POINTS

A cue point is the exact point playback will begin when the *PLAY/PAUSE BUTTON (16)* is pressed. A cue point may be created anywhere on a disc or in a track.

Use the *JOG WHEEL (20)* to set a cue point by frame. While the disc is in pause or cue mode, use the *JOG WHEEL (20)* to scroll through a track to find your desired starting point. Once you have found your desired cue point press the *PLAY BUTTON (16)* to enter this point in to the unit's memory. At this point when ever the *CUE BUTTON (18)* is pressed it will return the track to this exact point.

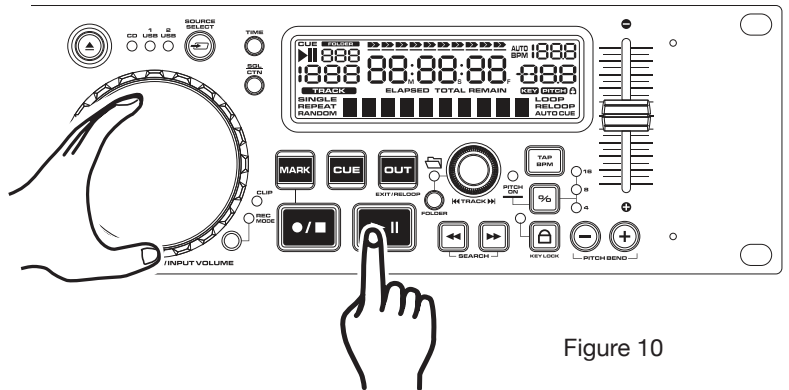

Figure 10

## 11. FRAME SEARCH

This feature allows you to scroll through a track to set a cue, or loop point. To use the scroll function you must first be in Pause Mode or Cue Mode. Once you are in Pause or Cue mode, use your finger tip or hand to turn the *JOG WHEEL (20)* to scroll through the track (figure 11). Turning the wheel in a clockwise direction will advance the frame search and turning the wheel in a counter-clockwise direction rewinds the frame search. When you use the *JOG WHEEL (20)* the monitor (headphone level) of a mixer allows you to here what you are scrolling through. Once you reach your desired starting point you can set a cue (starting) point by pressing the *PLAY/PAUSE BUTTON (16)* as in figure 11. Pressing the *CUE BUTTON (18)* will return the disc to the cue point just set.

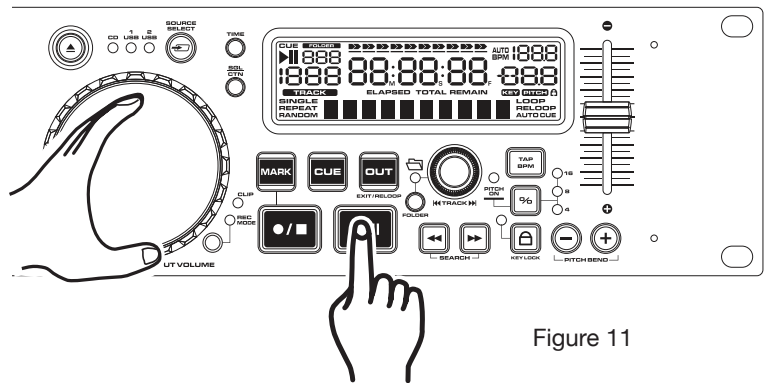

Figure 11

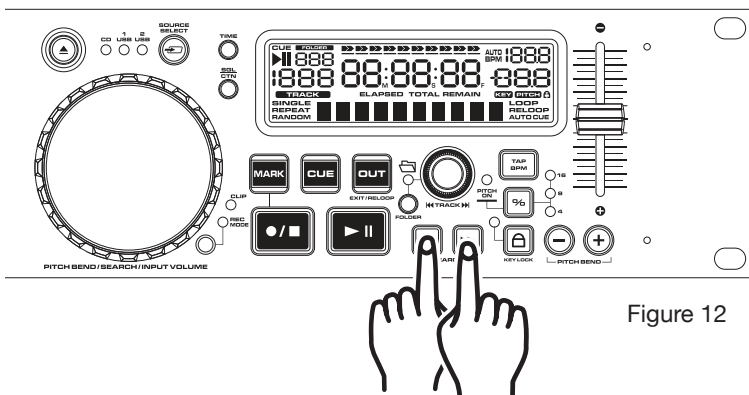

Figure 12

## 10. FRAME SEARCH (FORWARD / REVERSE)

This function lets you a frame search through a track. To do this press either the forward or reverse *SEARCH BUTTONS (14)*.

## BASIC OPERATION

### 11. CHANGING THE TIME DISPLAY (29)/TIME BAR (30):

The time may be displayed in three different modes; Total Remain, Remain, and Elapsed. During normal playback, pressing the *TIME BUTTON* (5) as in figure 13, will change the time display information (29) in the LCD. The following is a break down of the time settings and their definitions:

- 1) TOTAL REMAIN (34) - This details the time in the *LCD* as the current CDs' total remaining time.
- 2) REMAIN (34) - This details the time in the *LCD* as the current tracks' remaining running time.
- 3) ELAPSED - This details the time in the *LCD* as the current tracks' elapsed running time.

**The unit will indicate the ELAPSED time when neither the TOTAL REMAIN OR REMAIN indicators are showing. Note: When playing a Mp3 disc the TOTAL REMAIN time of a disc cannot be shown. Only the REMAIN time and ELAPSED time of the track.**

**TIME BAR INDICATOR** - The time bar in the LCD visually details the time defined in the *TIME METER* (30). This bar is also dependent on the selected time function; *REMAIN* (38) or *TOTAL REMAIN* (38). This bar will begin to flash when 15 seconds of a track remain and will begin to rapidly flash when three seconds of a track remain. The flashing bar is a great visual reminder a track is about to end. The flashing bar will function regardless of which time mode the unit is in.

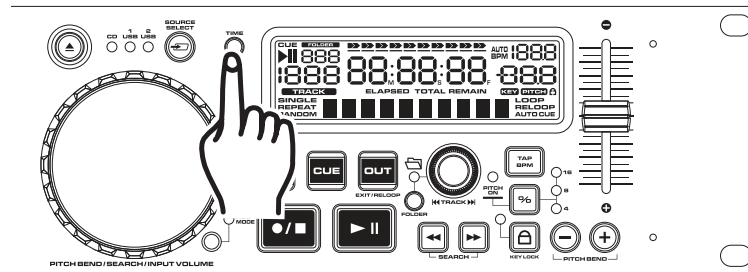

Figure 13

# BASIC OPERATION

## 12. PITCH ADJUSTMENTS

This function will increase or decrease the playback speed or "PITCH," of a track. The maximum pitch bend percentage allowed is +/-100% for CD track's and +/-16% for USB mp3's. The *PITCH SLIDER* (9) is used to decrease or increase the playback pitch. If the slider is move up (towards the top of the unit) the pitch will decrease, if the slider is moved down (towards the bottom of the unit) the pitch will increase.

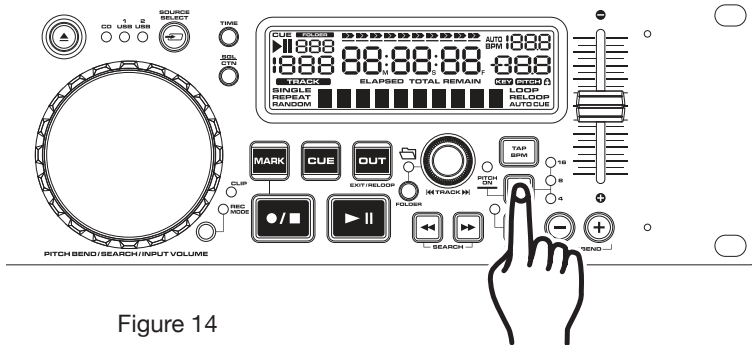

Figure 14

**Using the Pitch Slider (9):** To use the *PITCH SLIDER* (9) slide the slider up and down. Down will increase the pitch and up will decrease the pitch. When the slider is in the center position, there is zero pitch being applied to a track.

**Activating the Pitch Slider (9):** To activate the *PITCH SLIDER* (9), you must turn the pitch function on. Press the *PITCH BUTTON* (11) for at least 2 seconds to turn on the pitch function, when the pitch function is activated the *PITCH LED* will begin to glow. If the pitch function is not activated the *PITCH SLIDER* (9) will not function.

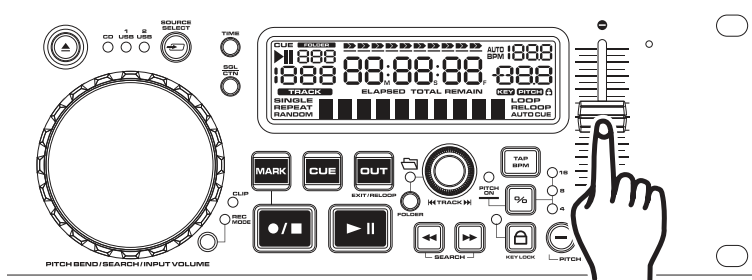

Figure 15

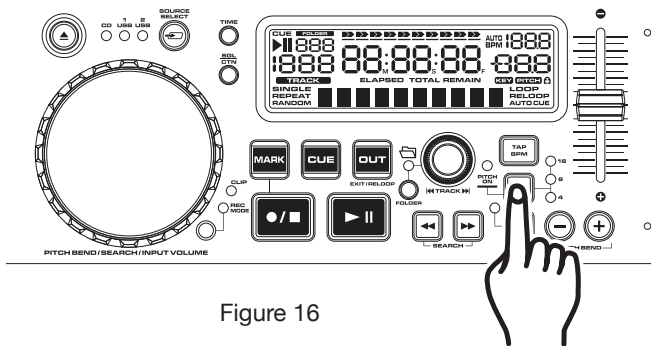

Figure 16

**Using the Pitch Slider Percentage Selector (9):** You may choose a pitch operating range at any time. To change the operating range be sure the pitch function is turned on, see figure 17. The pitch percentage can be changed between +/-4%, +/-8%, +/-16%, and 100%. 4% will allow the least amount of pitch manipulation and 100% will allow the most amount of pitch manipulation. To adjust the different values, press the *PITCH ON/OFF BUTTON* (9) and Tap on the % *BUTTON* (9) until your desired value is reached. The L.E.D. of the % *BUTTON* (9); glowing yellow for 4%, glowing green for 8%, or glowing red for 16%, and all LEDs glowing for 100%.

## BASIC OPERATION

### 13. PITCH BEND

This function will *momentarily* increase or decrease a tracks playback speed using the (-) & (+) **PITCH BUTTONS (12)**. The maximum pitch bend percentage allowed is +/-16%. The pitch bend function will work in conjunction with the **PITCH SLIDER (9)** pitch setting. For example, if the **PITCH SLIDER (9)** is set to a 2% pitch gain the pitch bending process will begin at 0% and will continue to the maximum of -/+16%.

#### PITCH BEND BUTTONS (11)

The (+) **PITCH BEND BUTTON (12)** will provide a speed bump and the (-) **PITCH BEND BUTTON (12)** will provide a slow down. The extent to which the speed changes is proportionate to the amount of time the button is pressed. For example, if the (+) **PITCH BEND BUTTON (12)** is held down continuously, the disc speed will increase and will continue to increase until it reaches a maximum of 16% speed gain. When you release the (+) **PITCH BEND BUTTON (12)** the disc speed will automatically return to it's previous speed.

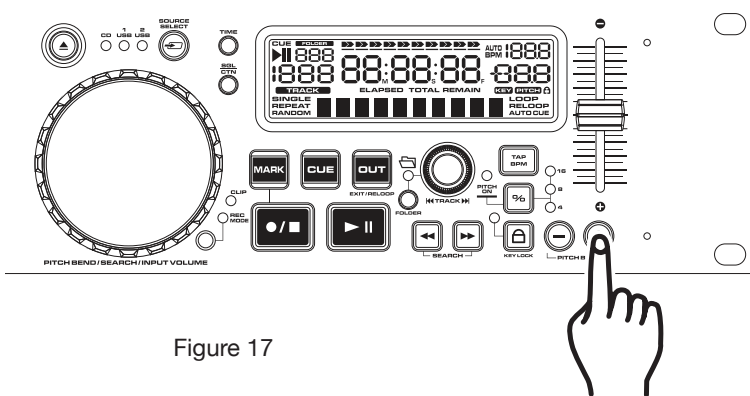

Figure 17

Holding down or tapping on the (+) **PITCH BEND BUTTON (12)** will provide a speed bump in the playback pitch.

Holding down or tapping on the (-) **PITCH BEND BUTTON (12)** will provide a slow down in the playback pitch.

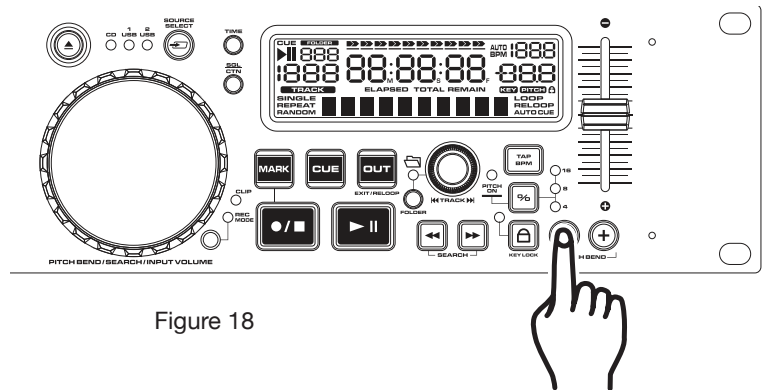

Figure 18

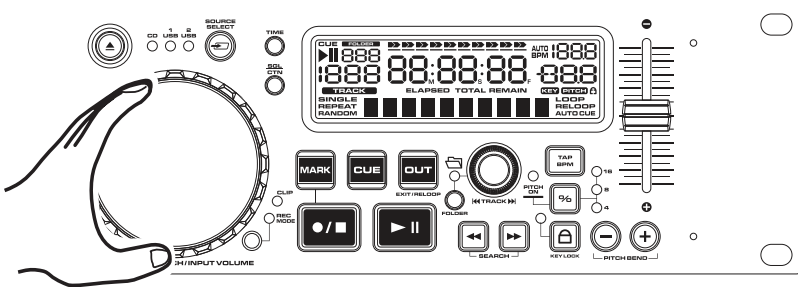

Figure 19

#### JOG WHEEL (20)

The **JOG WHEEL (20)** will temporarily bend the pitch if a track is in play mode. Turning the wheel in a clockwise direction will increase your track pitch and turning the wheel in a counter-clockwise direction will slow your track pitch. The speed you rotate the **JOG WHEEL (20)** will determine pitch bend percentage, to a maximum of +/-100%.

# BASIC OPERATION

## 14. CREATING AND PLAYING A SEAMLESS LOOP

A seamless loop is a sound loop that plays continuously without sound interruption. You can use this loop to create dramatic effect in your mixing. This loop has no time limit and you could actually loop the entire length of disc.

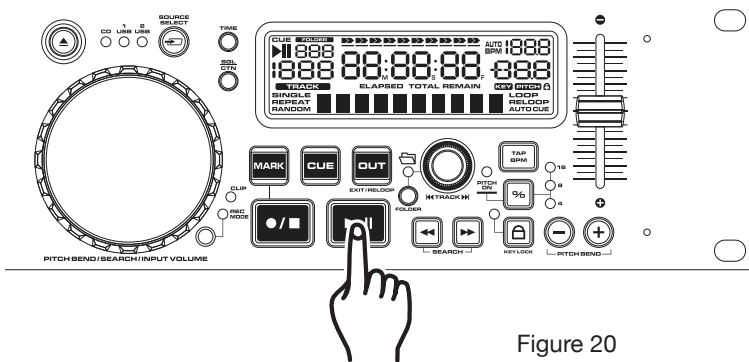

1) Press *PLAY/PAUSE BUTTON (16)* to activate playback mode.

2) Press the *OUT/EXIT/RELOOP BUTTON (18)*. This will set the starting point of the SEAMLESS LOOP (figure 21). The *OUT/EXIT/RELOOP BUTTON (18)* will blink.

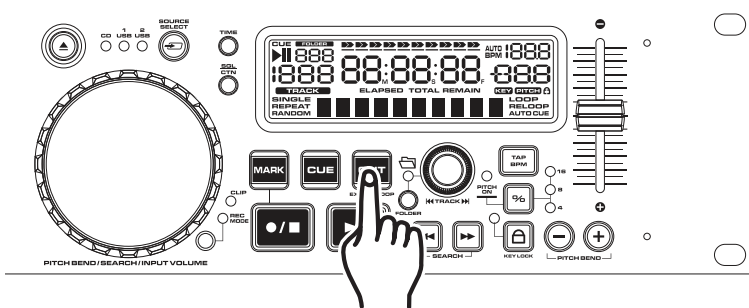
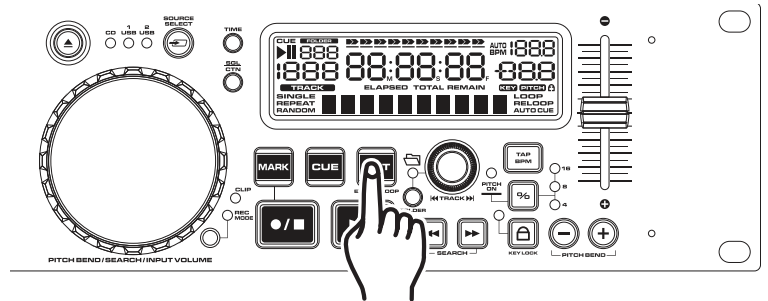

3) Press the *OUT/EXIT/RELOOP BUTTON (18)* to set the ending point for your SEAMLESS LOOP (Figure 22). The *OUT* and *IN* BUTTONS will stay lit indicating a SEAMLESS LOOP is playing. Press the *OUT BUTTON* again to stop the Loop.

4) Press the *OUT/EXIT/RELOOP BUTTON (18)* to reactivate the SEAMLESS LOOP. Press the *OUT/EXIT/RELOOP BUTTON (18)* to deactivate the loop.

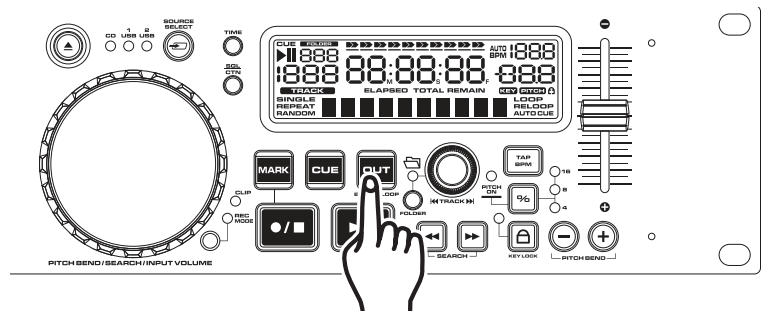

## **BASIC OPERATION**

### **15. RECORDING**

This function will allow you to record to a USB stick. Insert a USB stick into the front or rear USB slot. Insert your desired CD or connect your desired playing device connected to the rear R&L RCA inputs.

#### **Recording to a USB stick from a playing CD:**

1. Insert the USB stick into either the front or rear slot, and load your desired CD.
2. Press the TIME BUTTON (5) for at least 5 seconds to access the internal menu. Rotate the TRACK/FOLDER KNOB until "5.REC. USB" is displayed, and press the knob. Rotate the knob to find the USB stick you are recording to either USB1 (front) or USB2 (rear). Press the knob to make your selection.
3. After you have selected the USB port you are recording to rotate the FOLDER KNOB (8) until "9. REC. Select" is displayed.
4. Turn the TRACK/FOLDER KNOB (8) so that "Internal" is displayed. Press the knob again to select the option.
5. After selecting "Internal" rotate the knob so that "C. Exit & Save" is shown, and press the knob.
6. Find your desired song/folder/album and press the RECORD BUTTON (17) and press the PLAY/PAUSE BUTTON (16). To stop recording press the RECORD BUTTON (17).

#### **Recording to a USB stick from an external audio device:**

1. Insert the USB stick into either the front or rear slot. Connect your external audio device to the RCA inputs located on the rear of the UCD-100 MKIII.
2. Press the TIME BUTTON (5) for at least 5 seconds to access the internal menu. Rotate the TRACK/FOLDER KNOB until "5.REC. USB" is displayed, and press the knob. Rotate the knob to find the USB stick you are recording to either USB1 (front) or USB2 (rear). Press the knob to make your selection.
3. After you have selected the USB port you are recording to rotate the FOLDER KNOB (8) until "9. REC. Select" is displayed.
4. Turn the TRACK/FOLDER KNOB (8) so that "External" is displayed. Press the knob again to select the option.
5. After selecting "Internal" rotate the knob so that "C. Exit & Save" is shown, and press the knob.
6. Press the RECORD BUTTON (17) and begin play on your external audio device. To stop recording press the RECORD BUTTON (17).

## INTERNAL MENU

Hold TIME BUTTON for 5 seconds to enter the internal menu. Turn the TRACK/FOLDER KNOB (8) to scroll through the different menus and press the TRACK/FOLDER KNOB to enter the corresponding submenu. Turn TRACK/FOLDER KNOB to change the submenus and press TRACK/FOLDER KNOB to memorize your settings in any operating mode.

### 1. Playlist – Normal / Title/ Artist / Album/ Genre

Normally the unit will read your USB devices in order of folder name and file names in folders. Title, Artist, Album and Genre will use your last built database file when scrolling through the selected database in alphabetical order. When new files are added it is necessary to build a new database for the MP3 files to read in any mode described.

### 2. Sleep Time – No sleep, 5~120 min

Set the time the player takes to enter sleep mode. When in sleep mode, the player will either read sleep or ZZZZZ on the LCD screen.

### 3. Line Setup – MODE= 1~3(Line mode)

Dis=0.5~12.0 sec. (LINE NAME start/stop time adjustment)

Run=50~2000 msec. (LINE NAME move time adjustment)

### 4. Bit rate – Display ON/OFF

Display the bit rate off MP3 files.

### 5. Rec. USB - Select the recording device between USB1 & USB2. (The default setting is USB1)

### 6. Rec. Bitrate - Select the Rec. Bitrate between WAV / 64K / 128K (Defaults) / 192K / 256K / 320K.

### 7. REC. Input - Auto / Manual Input level

### 8. OUT Mode - Playback (Defaults) / REC MON

### 9. REC. Select - External / Internal Record source select (External is the default setting).

#### A. Version – CON:XX (Control version)

DSP:XX (DSP version)

#### B. Load Default – Press TRACK Knob to enter load defaults. (LCD displays “Load OK”.)

Will reset all settings to factory default except for Firmware version.

#### C. Exit & Save – Exit & Save setting to next power on (LCD displays “Saving”.)

This will save all changes if changes are not saved the unit will revert to last saved changes on power off.

Press the TRACK knob to fast exit & save in any operating mode.

#### NOTE:

**SLEEP TIME:** The CD player automatically shuts off the transport and laser after about 15 minutes when in

pause or cue mode). This extends the life of your motor drive and laser. During sleep mode the display shows the word “SLEEP”. To wake up the player, just press the cue or play button, the display turns to normal and is ready to receive instructions. You can enter the Sleep Time menu to adjust sleep time,

range

is 5~120 minutes.

**SAVE:** PITCH ON/OFF, PITCH RANGE, SGL/CTN, AUTO CUE, TIME MODE, KEY LOCK, DISPLAY/RUN TIME/BIT RATE, REPEAT MODE, PLAYLIST, SLEEP TIME, LINE SETUP.

**DEFAULTS:** PITCH (ON), PITCH RANGE (8%), PLAY MODE(CTN), AUTO CUE(ON), TIME MODE (REMAIN), KEY LOCK(OFF), BIT RATE(Disp. ON), REPEAT MODE (OFF), PLAYLIST (NORMAL), SLEEP TIME (15 min), LINE SETUP(model 1), DISPLAY(1 sec),RUN TIME(150msec)

## Minimum Hardware Requirements:

CPU: Intel Pentium 4 1GHz processor or above, Intel Centrino Mobile Technology 1.6GHz

RAM: 512MB RAM

DISC SPACE: 100MB of free disc space needed

OS: Microsoft Windows XP SP3, Vista SP2, Windows 7

The device includes a database DB management software that enables you to search for your files by Title, Artist, Album, and Genre.

## Installation:

Refer to the following figures for installing database management software on your computer.

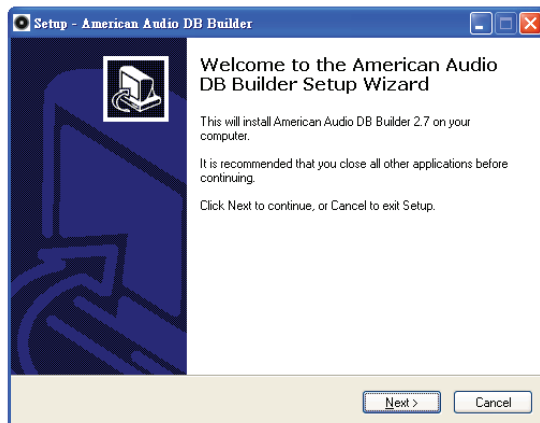

Step 1: Click Next >

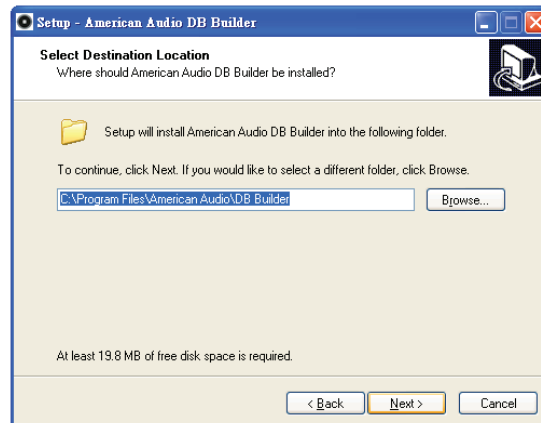

Step 2: Click Next >

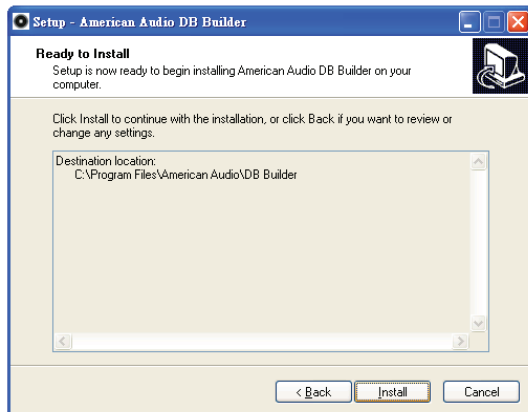

Step 3: Click Install

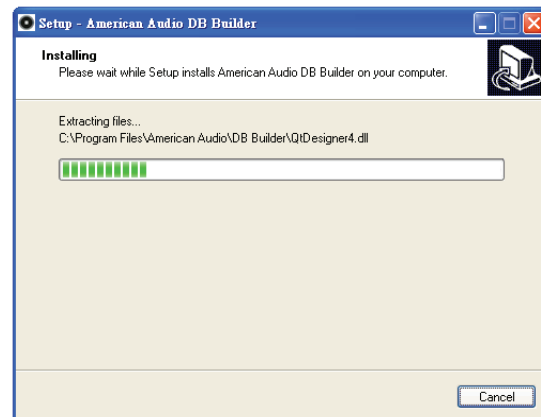

Step 4: Processing

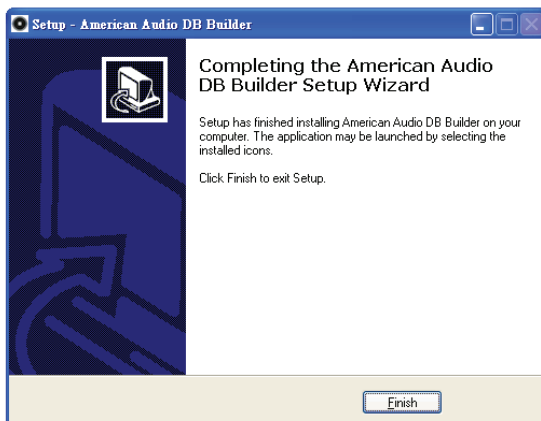

Step 4: Click Finish

The database builder will scan your USB hard drive and create database files so that you may locate the files in your music library to your liking.



To open the database builder, “click” on your start menu, then programs, then American Audio, Database Builder. To build a database your hard drive must FAT formatted.

**Build database file** on memory device.

**Format** the selected source. Note: Make sure that all files are backed up prior to formatting your device.



**Drive Selector:** Select your desired drive to format or build a database file.

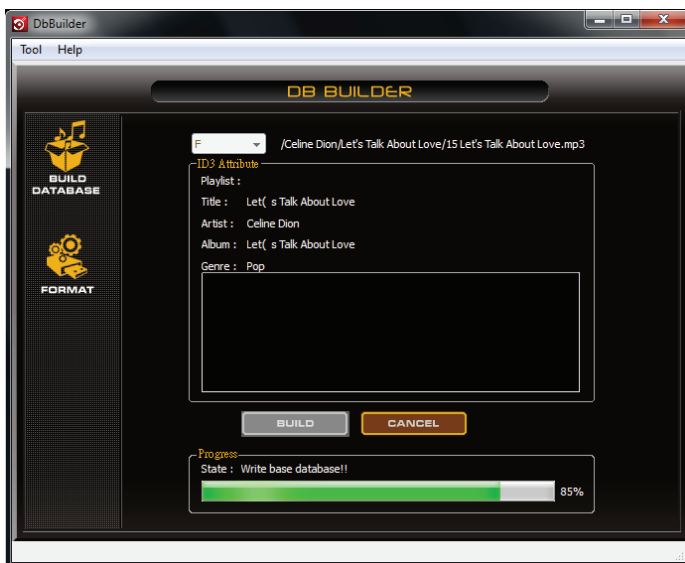

How to format your memory device.

1. Select your desired device in the drop down menu.
2. Click Format, on the modes in the left column.
3. Click Format. For best results set the cluster size to Auto.

How to create a database file.

1. Select your desired device.
2. Select Build Database in the left column.
3. Click Build.

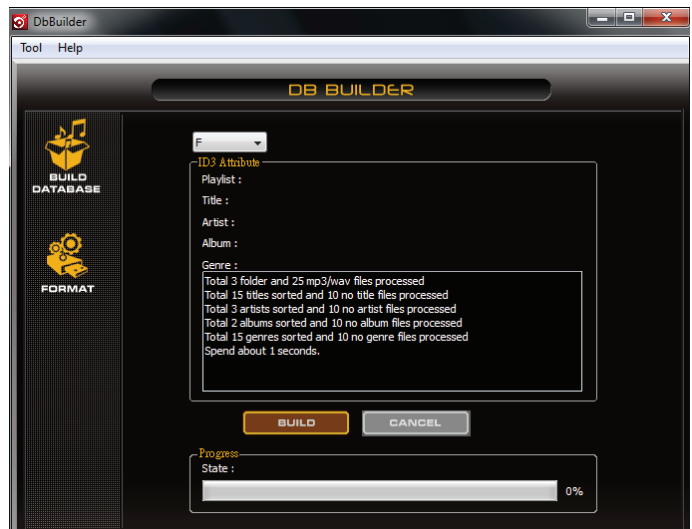

# DATABASE BUILDER

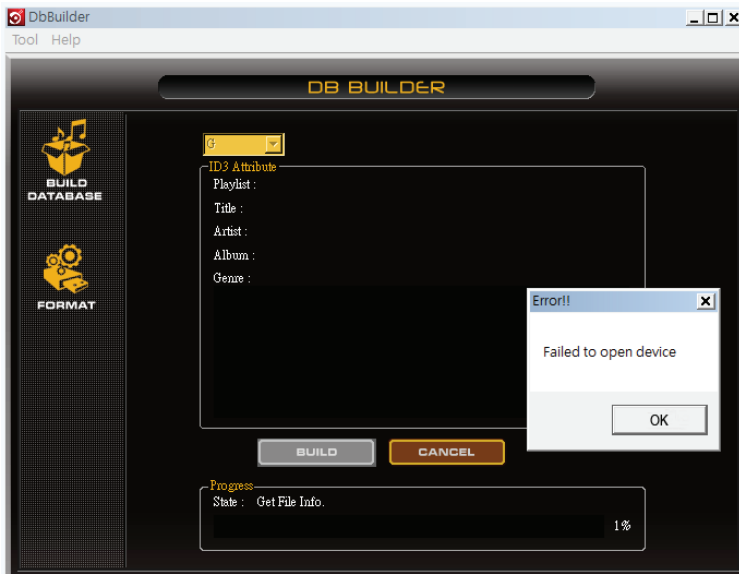

Errors:

1. Failed to Open Device: Your drive is a non supported format.
2. File Error: This is due to MP3 file not have a identified ID3 tag.

Windows 7/Vista may warn you according to your security settings. Select Allow if you wish to install the database builder program.

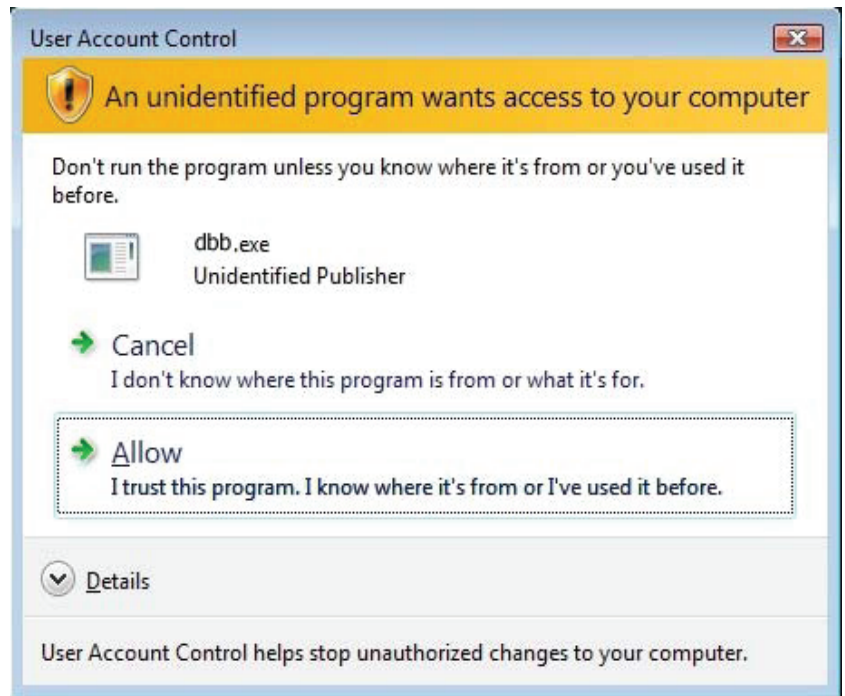

## TROUBLESHOOTING

|                                                  |                                                                                                                                                                                                                                                                                                                                                                                                                                                                                                                                                 |
|--------------------------------------------------|-------------------------------------------------------------------------------------------------------------------------------------------------------------------------------------------------------------------------------------------------------------------------------------------------------------------------------------------------------------------------------------------------------------------------------------------------------------------------------------------------------------------------------------------------|
| Disc Read Error                                  | <p>The disc is unable to read in the CD drive, make sure that the disc is clean and not scratched. If the problem continues try a different CD, make sure that the CD is CDA or MP3 format.</p> <p>If the disc takes over 20 seconds or more to read the CD lens will stop reading, this means the disc TOC was unreadable. Try another disk or clean the troubled disc.</p> <p>If problems continue with CD drives call American Dj service.</p>                                                                                               |
| USB device not reading                           | <p>When using Hard Drives it is recommended that you use a hard drive with an external power supply or one that does not exceed 5 volt power consumption. If your hard drive resets itself when plugged into the USB ports on the UCD-100 MKIII you may need an external power supply. Contact your device manufacture for accessory information.</p> <p>If the drive doesn't read the device, make sure that your device is formatted to a compatible FAT format. <b>WARNING-DO NOT FORMAT YOUR DEVICE WITH OUT BACKING UP YOUR FILES.</b></p> |
| Music files not found in USB device or Data base | <ul style="list-style-type: none"> <li>-Make sure that the file is an MP3 file.</li> <li>- If it does not show up on the database modes ( album; artist; etc) use the database builder to update you library.</li> </ul>                                                                                                                                                                                                                                                                                                                        |
| File Error when building dB file                 | <p>Remove the file that cause the database builder to stop and try again, if problem continues remove the folder and try again.</p>                                                                                                                                                                                                                                                                                                                                                                                                             |

## POWER DOWN

- When you have finished using the CD unit, and before switching off the power, be sure that the disc holder has been closed with the *OPEN/CLOSE BUTTON*.
- TRAY PROTECTION: If tray is not closed after 60 seconds, it will close automatically and pause.

**CAUTION:** DO NOT forcibly close the disc holder when the power is off.

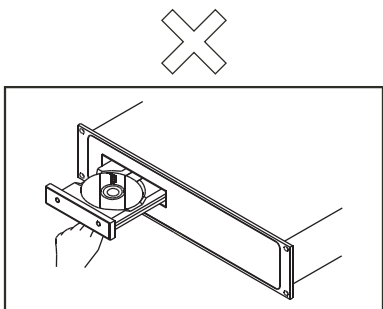

Do not switch off the power when the disc holder is open.

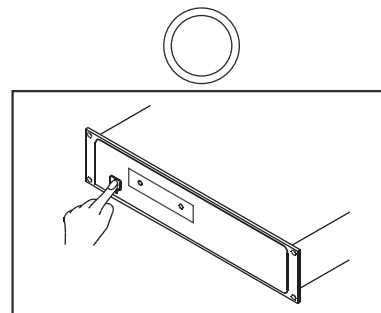

To avoid damage, please don't switch off the power until "no disc" or "time code" is showed on the LCD after the disc holder has been closed with the *OPEN/CLOSE button*.

DO NOT switch off the power when the disc holder is open. Switch off the power after the disc holder has been closed with the *OPEN/CLOSE BUTTON*.

## COMPACT DISC

### 1. PRECAUTIONS ON HANDLING COMPACT DISCS

Compact disc are constructed of the same types of plastic record are. To avoid severe damage to you valuable disc please observe the following guide lines. Following the these guide lines will ensure long disc life.

- Do not allow fingerprints, oil or dust to get on the surface of the disc. If the disc is dirty, wipe it off with a soft dry cloth.
- Do not use benzene, thinner, water, record spray, electrostatic-proof chemicals, or silicone-treated cloths to clean discs.
- Always handle discs carefully to prevent damaging the surface; in particular when removing a disc from its edges.
- Do not bend the disc.
- Do not apply heat.
- Do not enlarge the hole in the center of the disc.
- Do not write on the label (printed side) with a hard tipped implement such as a pencil or ball point pen.
- Condensation will form if a disc is brought into a warm area from a colder one, such as outdoors in winter. Do not attempt to dry the disc with a hair dryer, etc.

### 2. PRECAUTION ON STORAGE

- After playing a disc, always unload it from the unit.
- Always store the compact disc in the jewel case, protecting from dirt or damage.
- Do not place discs in the following areas:
  - a) Areas exposed to direct sunlight for a considerable time.
  - b) Areas subject to accumulation of dust or high humidity.
  - c) Areas affected by heat from indoor heaters, etc.

## **WARRANTY**

### **1-YEAR LIMITED WARRANTY**

- A. American Audio® hereby warrants, to the original purchaser, American Audio® products to be free of manufacturing defects in material and workmanship for a period of 1 Year (365 days) from the date of purchase. This warranty shall be valid only if the product is purchased within the United States of America, including possessions and territories. It is the owner's responsibility to establish the date and place of purchase by acceptable evidence, at the time service is sought.
- B. For warranty service, send the product only to the American Audio® factory. All shipping charges must be pre-paid. If the requested repairs or service (including parts replacement) are within the terms of this warranty, American Audio® will pay return shipping charges only to a designated point within the United States. If the entire instrument is sent, it must be shipped in its original package. No accessories should be shipped with the product. If any accessories are shipped with the product, American Audio® shall have no liability whatsoever for loss of or damage to any such accessories, nor for the safe return thereof.
- C. This warranty is void if the serial number has been altered or removed; if the product is modified in any manner which American Audio® concludes, after inspection, affects the reliability of the product; if the product has been repaired or serviced by anyone other than the American Audio® factory unless prior written authorization was issued to purchaser by American Audio®; if the product is damaged because not properly maintained as set forth in the instruction manual.
- D. This is not a service contract, and this warranty does not include maintenance, cleaning or periodic check-up. During the period specified above, American Audio® will replace defective parts at its expense, and will absorb all expenses for warranty service and repair labor by reason of defects in material or workmanship. The sole responsibility of American Audio® under this warranty shall be limited to the repair of the product, or replacement thereof, including parts, at the sole discretion of American Audio®. All products covered by this warranty were manufactured after January 1, 1990, and bear identifying marks to that effect.
- E. American Audio® reserves the right to make changes in design and/or improvements upon its products without any obligation to include these changes in any products theretofore manufactured.
- F. No warranty, whether expressed or implied, is given or made with respect to any accessory supplied with products described above. Except to the extent prohibited by applicable law, all implied warranties made by American Audio® in connection with this product, including warranties of merchantability or fitness, are limited in duration to the warranty period set forth above. And no warranties, whether expressed or implied, including warranties of merchantability or fitness, shall apply to this product after said period has expired. The consumer's and or Dealer's sole remedy shall be such repair or replacement as is expressly provided above; and under no circumstances shall American Audio® be liable for any loss or damage, direct or consequential, arising out of the use of, or inability to use, this product.
- G. This warranty is the only written warranty applicable to American Audio® Products and supersedes all prior warranties and written descriptions of warranty terms and conditions heretofore published.

# SPECIFICATIONS

**GENERAL** Model: American Audio® UCD-100 MKIII - Professional Compact Disc/USB Player

**System:** Single CD Tray Loading, Digital Compact Disc Audio Player.  
**Disc type:** Standard compact discs (5 in /12cm and 3in/8cm discs)  
**Dimensions:** 19" (W) x 3.5" (H) x 10.5" (D)  
 482mm (W) x 88.8mm (H) x 270.5mm (D)  
**Installation:** Place on flat surface or mount in flat case  
**Weight:** 9 Lbs. / 4.25kgs  
**Power supply:** AC 100 - 240V, 50/60Hz  
**Power consumption:** 13W  
**Pitch control range:** +/-4%, +/-8%, +/-16%, and 100% (100% only applies to Standard CD's)  
**Pitch bend:** +/-4%, +/-8%, +/-16%, and 100% (100% only applies to Standard CD's)  
**Pitch accuracy:** 0.1%  
**Environmental conditions:** Operational temperature: 23+/-2°C (73 to 35°F)  
 Operational humidity: 5 to 65% RH (non-condensation)  
 Storage temperature: -20 to 60°C (4 to 140°F)

**Accessories:** 2 x RCA Cables  
 AC Power Cord  
 Remote Control

## AUDIO SECTION

**Quantization:** 16 bit linear per channel  
**Sampling rate:** 44.1 kHz at normal pitch  
**Over sampling rate:** 8 times over sampling 1 bit D/A converter  
**D/A conversion:** 16 bit  
**Frequency response:** 20Hz to 20KHz +/-0.4dB (For CDDA)  
**Output level:** 2.0Vrms +/-0.5dB  
**Load impedance:** 47k ohm or more

**AUDIO CHARACTERISTICS (TEST DISC: TCD-782 & TCD-781; USB TEST FORMAT: MP3, 128KBPS; LOAD=100Kohm):**

| ITEM                       | TYPICAL           | LIMIT            | CONDITION                      |
|----------------------------|-------------------|------------------|--------------------------------|
| Output level (CD):         | 2Vrms +/-0.5dB    | 2Vrms+/-1dB      | 1KHz, 0dB (TCD782, TRK2)       |
| Output level (USB):        | 2Vrms +/-0.5dB    | 2Vrms+/-1dB      | 1KHz, 0dB (TCD782, TRK2)       |
| Channel balance:           | Within 0.2dB      | Within 1dB       | 1KHz, 0dB (TCD782, TRK2)       |
| Frequency response (CD)    | 17-20KHZ +/-0.4dB | 17-20KHZ +/-1dB  | 0dB OUTPUT (TCD782, TRK2/3/7)  |
| Frequency response (USB)   | 17-16KHZ +/-0.1dB | 17-16FKHZ +/-1dB | 0dB OUTPUT (TCD782, TRK1/4/16) |
| De-emphasis response (CD): | -20dB +/-0.2dB    | -20dB +/-1dB     | 16KHz,-20dB (TCD782, TRK2/14)  |
| Channel separation *2:     | 93dB              | 85dB             | 1KHz, 0dB (TCD782, TRK2/9/11)  |
| T.H.D. + NOISE*1 (CD):     | 0.008%            | 0.015%           | 1KHz, 0dB (TCD782, TRK2)       |
| T.H.D. + NOISE*1 (USB):    | 0.007%            | 0.015%           | 1KHz, 0dB (TCD782, TRK2)       |
| S/N ratio (IHF-A)*2 (CD):  | 126dB             | 90dB             | 1KHz, 0dB (TCD782, TRK2/8)     |
| S/N ratio (IHF-A)*2 (USB): | 85dB              | 80dB             | 1KHz, 0dB (TCD782, TRK2/8)     |
| Dynamic Range*2 (CD):      | 92dB              | 88dB             | 1KHz, -60dB (TCD782, TRK18)    |

NOTE: \*1 With 20KHz low pass filter.  
 \*2 With 20KHz low pass filter, "IHF-A" Weighted

## CD SEARCHING TIME (TEST DISC: TCD-792)

| ITEM              | TYPICAL | LIMITS | CONDITION                               |
|-------------------|---------|--------|-----------------------------------------|
| Short access time | 2 sec   | 4 sec  | Play next track                         |
| Long access time  | 4 sec   | 6 sec  | Track 1 ->Track 20 / Track 20 ->Track 1 |

## PLAYABILITY

| ITEM               | TYPICAL | LIMIT | CONDITION               |
|--------------------|---------|-------|-------------------------|
| Interruption       | 1mm     | 0.7mm | TCD-725                 |
| Black dot          | 1mm     | 0.6mm | TCD-725                 |
| Finger prints      | 75um    | 65um  | TCD-725                 |
| Eccentricity       | 140um   | 140um | TCD-712, W/O TRACK JUMP |
| Vertical deviation | 1mm     | 0.5mm | TCD-731R                |
| Scratch            | 2mm     | 1.2mm | TCD-721, W/O TRACK JUMP |

## SPECIFICATIONS

### SOUND RECORDING

Menu Record Input Auto/Rec Bit Rate: Wav. (Rec Input 1KHz / +10dBV)  
 Play Audio Files Level 1KHz / 4dBV +/-2dBV  
 THD+N Less Than 0.015% (W/20KHz LPF, A-Weighted)

Menu Record Input Manual/Rec Bit Rate: Wav. (Rec Input 1KHz / -4dBV) / Gain 0dBV  
 Play Audio Files Level 1KHz / 0dBV +/-2dBV  
 THD+N Less Than 0.03% (W/20KHz LPF, A-Weighted)

### PICK-UP

System Object lens drive system optical pick-up  
 Object lens drive system 2 dimensional parallel drive  
 Tracking detection 3 spot beam detection  
 Optical source Semiconductor laser  
 Wave length 780nm

### MP3 FORMAT

|                     |                                                                                                                                                                  |                                                                                                                                                  |
|---------------------|------------------------------------------------------------------------------------------------------------------------------------------------------------------|--------------------------------------------------------------------------------------------------------------------------------------------------|
| Disc Format         | Applicable file extensions                                                                                                                                       | mp3. MP3. mP3. Mp3                                                                                                                               |
|                     | ISO9660                                                                                                                                                          | Max. 63 characters                                                                                                                               |
|                     | Joliet                                                                                                                                                           | Max. 63 characters                                                                                                                               |
|                     | CD-ROM sector format                                                                                                                                             | mode-1 only                                                                                                                                      |
|                     | Max. number of Folders                                                                                                                                           | 255                                                                                                                                              |
|                     | Max. number of files                                                                                                                                             | Max. 999 files (* note #1)                                                                                                                       |
| USB Format          | File System                                                                                                                                                      | FAT 12/16/32                                                                                                                                     |
|                     | Applicable file extensions                                                                                                                                       | mp3. MP3. mP3. Mp3                                                                                                                               |
|                     | Max. number of files                                                                                                                                             | Max. 999 files                                                                                                                                   |
| MP3 Format          | MPEG 1 Layer 3 standard (ISO/IEC 11172-3), which provides for single channel ('mono') and two-channel ('stereo') coding at sampling rates of 32, 44.1 and 48kHz. | 32/40/48/56/80/96/112/128/160/192/224/256/320 kbps<br>Xing/VBRI VBR                                                                              |
|                     | MPEG 2 Layer 3 standard (ISO/IEC 13818-3), which provides for similar coding at sampling rates of 16, 22.05 and 24 kHz.                                          | 32/40/48/56/64/80/96/112/144/160 Kbps<br>Xing/VBRI VBR                                                                                           |
|                     | MPEG 2.5 Layer 3 standard, which provides for similar coding at sampling rates of 8, 11.025 and 12 kHz.                                                          | 32/40/48/56/64/80/96/112/144/160 Kbps<br>Xing/VBRI VBR                                                                                           |
| Disc Writing Method | Disc at Once and Track at Once                                                                                                                                   |                                                                                                                                                  |
|                     | Multi Session                                                                                                                                                    | If the 1 <sup>st</sup> session is CDDA, you can playback Only CDDA track, If the 1 <sup>st</sup> session is MP3, you can playback only MP3 file. |

Note #1: max.255 files each folder



©American Audio®  
A Division of the American DJ® Group of Companies  
American Audio® World Headquarters:  
6122 S. Eastern Ave.  
Los Angeles, CA 90040 USA  
Tel: 323-582-2650 Fax: 323-582-2610  
Web: [www.americanaudio.us](http://www.americanaudio.us) E-mail: [info@AmericanAudio.us](mailto:info@AmericanAudio.us)