











CRONO LED 20



IP65

CE, RoHS

-  IP65
-  220 ÷ 240Vac
-  20W
-  SMD LED
-  Light Sensor
-  Light Sensor
-  Cable
-  White Body
-  Aluminium+temp. glass
-  -35°C
+55°C
-  50000 ore (L80B20)



CRONO 20
cod. **AR10020-WW**
Temp. Col. 3000K
Warm White

CRONO 20
cod. **AR10020-NW**
Temp. Col. 4000K
Natural White

CRI ≥ 80					
LED 140 lm/W					
 GRUPPO 0 RISCHIO FOTOBIOLOGICO					
 Questo dispositivo è munito di lampade a LED integrate					
<table style="border: none;"> <tr> <td style="border: 1px solid black; padding: 2px;">A++</td> <td rowspan="3" style="font-size: 2em; padding: 0 10px;">}</td> <td rowspan="3" style="border: none;">LED</td> </tr> <tr> <td style="border: 1px solid black; padding: 2px;">A+</td> </tr> <tr> <td style="border: 1px solid black; padding: 2px;">A</td> </tr> </table>	A++	}	LED	A+	A
A++	}			LED	
A+					
A					
 110°					

CRONO 20

The wide range of Crono floodlight from 10 to 200 Watt is suitable to light up architectural details as well as homogeneous wall washer for facades and vertical surfaces, also suitable for parking lots, parks, gardens and monuments. The Crono series is equipped with 100-400 Lux ambient light sensor with hysteresis +/- 50 Lux and sampling every minute for automatic on/off function. The SMD 230Vac LED module have a overheating protection system and high efficiency driver >PF 0.95 with a protection against electric discharges: Line-Line > 2KV / Line-GND > 4KV

Code	Input Volt	Color Temperature	Watt	PFC	Lumen	CRI	LED Chip	Beam Angle	Body Material	Front Material	Insulation Class	IP	IK
AR10020-WW	220-240Vac	3000K	20W	90	1771 lm	Ra>80	SMD LED	110°	Aluminium	Temp. Glass	I	IP65	08
AR10020-NW	220-240Vac	4000K	20W	90	1782 lm	Ra>80	SMD LED	110°	Aluminium	Temp. Glass	I	IP65	08

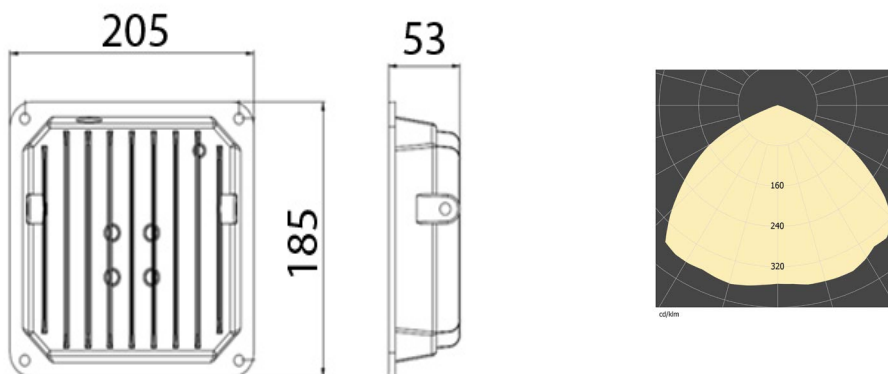

Arena Luci s.r.l. si riserva la facoltà di modificare le caratteristiche dei prodotti senza obbligo di preavviso
Arena Luci s.r.l. reserve the right to change products specifications at anytime without prior notice