











# CRONO LED 10



IP65

CE, RoHS

-  IP65
-  220 ÷ 240Vac
-  10W (AR10010)
-  SMD LED
-  110°
-  Light sensor
-  Cable
-  White Body
-  Aluminium+temp. glass
-  -35°C  
+55°C
-  50000 ore (L80B20)



**CRONO 10**  
cod. **AR10010-WW**

Temp. Col. 3000K  
**Warm White**

**CRONO 10**  
cod. **AR10010-NW**

Temp. Col. 4000K  
**Natural White**

CRI  
≥ 80

LED  
140 lm/W



**GRUPPO 0**  
RISCHIO  
FOTOBIOLOGICO

Questo dispositivo è  
munito di lampade  
a LED integrate

A++ }  
A+ } **L**  
A } **E**  
          **D**

110°

## CRONO 10

The wide range of Crono floodlight from 10 to 200 Watt is suitable to light up architectural details as well as homogeneous wall washer for facades and vertical surfaces, also suitable for parking lots, parks, gardens and monuments. The Crono series is equipped with 100-400 Lux ambient light sensor with hysteresis +/- 50 Lux and sampling every minute for automatic on/off function. The SMD 230Vac LED module have a overheating protection system and high efficiency driver >PF 0.95 with a protection against electric discharges: Line-Line > 2KV / Line-GND > 4KV

Code	Input Volt	Color Temperature	Watt	PFC	Lumen	CRI	LED Chip	Beam Angle	Body Material	Front Material	Insulation Glass	IP Grade	IK Rate
AR10010-WW	220-240Vac	3000K	10W	90	887 lm	Ra>80	SMD LED	110°	Aluminium	Temp. Glass	I	IP65	08
AR10010-NW	220-240Vac	4000K	10W	90	895 lm	Ra>80	SMD LED	110°	Aluminium	Temp. Glass	I	IP65	08

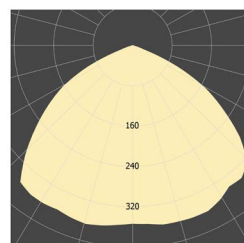
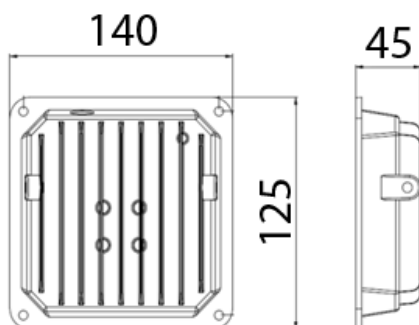

Arena Luci s.r.l. si riserva la facoltà di modificare le caratteristiche dei prodotti senza obbligo di preavviso  
Arena Luci s.r.l. reserve the right to change products specifications at anytime without prior notice

Distributed by AMLUX srl, 46042, Castel Goffredo (MN), info@amlux.it, www.amlux.it