



DKM SINGLE-PHASE DIMMABLE RECESSED 2MT ON DEMAND

Design: Studio Tecnico Ivela



Product code

7521-20-31

Color

White, on demand

General Specifications

Product type	: Tracks
Mounting type	: Ceiling - recessed
Description	: The 1-phase dimmable recessed track operates through a + / - polarized signal to manage a wide range of applications in the field of light planning. The use of the specific electro-mechanic adapter code 7559 is compulsory. It is made of extruded aluminium alloy. The copper wires are located inside extruded profiles in PVC, with high insulating properties.
Indoor/outdoor lights	: Indoor

Physical Specifications

Load capacity (Kg)	: The track has a load capacity of 2Kg every 200mm, with a maximum distance of 800mm between the fixing points. In case of 10Kg load every 200mm, a distance of 400mm between the fixing points is recommended.
Thermal Dissipation	: Passive

Electrical Specifications

Current (A)	: 16
Glow wire (°C)	: 850
Voltage (V)	: 230/250

Weight and Dimensions

Length (mm)	: 2000
Width (mm)	: 53
Height (mm)	: 33
Recessed hole (mm)	: 37

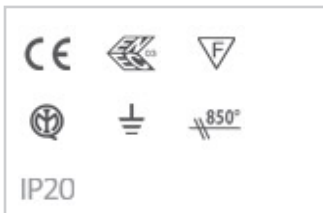
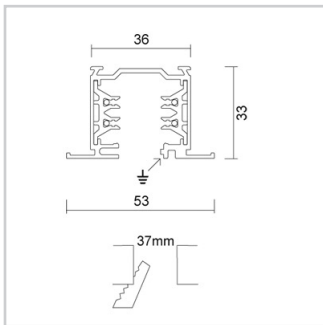

ACCESSORIES



Product Code : 7604-10-W30/31
Name : Electrical straight joint

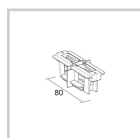

Product Code : 7654-10-W30/31
Name : Mechanical straight joint

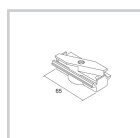

Product Code : 7625-00-30/31/52
Name : Mechanical adapter

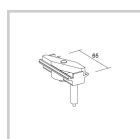

Product Code : 7618-00-30/31/52
Name : Mechanical adapter with automatic locking

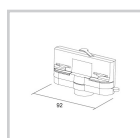

Product Code : 7559-00-20/30/31
Name : Electro/mechanical adapter

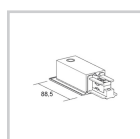

Product Code : 7665-10-W20/30/31
Name : Right live-end

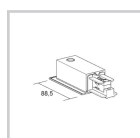

Product Code : 7665-11-W20/30/31
Name : Left live-end

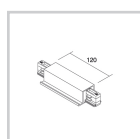

Product Code : 7666-10-W20/30/31
Name : Central connector and straight joint



Product Code : 7664-00-48
Name : Suspension for false ceiling



Product Code : 7659I-00-W20/30/31
Name : Dead end



Product Code : 7609-00-00
Name : Nut



Product Code : 7607-00-00
Name : Ceiling kit

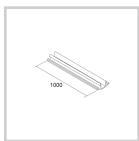

Product Code : 7624-00-30/31
Name : Track cover

Pictures and Applications

SCHEMA ELETTRICO / WIRING DIAGRAMS

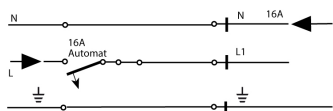

CAPACITÀ DI CARICO / LOAD CAPACITY

